

Table by the
Minister of Justice
& Public Safety

2015-05-13

Bauer

A Final Report on
A Feasibility Study for a 9-1-1
and/or
Enhanced (E-9-1-1)
System in the Province of
Newfoundland and Labrador

Pomax Inc.
Public Safety

March 30th, 2012

www.pomaxinc.com

[Faint handwritten notes in the top left corner, possibly including a date and some illegible text.]

[Faint, mirrored text, likely bleed-through from the reverse side of the page. The text is mostly illegible but appears to contain several lines.]

[Faint handwritten text in the lower middle section of the page.]

[Faint handwritten text at the bottom of the page.]



Table of Contents

I	Summary, Observations, and Conclusions.....	i
I.I	Introduction and Purpose.....	i
I.II	Scope.....	i
I.III	The Purpose of 9-1-1 and its Relationship to Emergency Response	ii
I.IV	Public Expectations.....	iii
II	9-1-1 Technology Background	iv
III	Governance and Legislation.....	v
IV	Technology Options.....	vi
IV.I	Basic 9-1-1.....	vi
IV.II	Enhanced and Next Generation 9-1-1	vii
IV.II.I	E9-1-1 Configuration Option 1: Bell Aliant Local Selective Router	vii
IV.II.II	E9-1-1 Configuration Option 2: Bell Aliant Remote Selective Router.....	vii
IV.II.III	NG9-1-1 Configuration Option 1: Bell Aliant Local NG9-1-1 Selective Router	vii
IV.II.IV	NG9-1-1 Configuration Option 2: Third Party NG9-1-1 Selective Router	vii
V	Civic Addressing.....	viii
VI	Staffing and Other Costs.....	x
VI.I	Cost Recovery.....	xii
VII	Conclusion and Recommendation.....	xiii
1.	Introduction and Purpose	1
1.1.	Scope	1
2.	Background.....	2
2.1.	9-1-1 Technology	2
2.2.	Location Fundamentals.....	3
2.3.	Infrastructure and Organizational Resources	3
2.4.	Public Expectations of 9-1-1	5
3.	Governance and Legislation.....	7
3.1.	Governance	7
3.2.	Legislation	10
4.	9-1-1 Technology and Operations.....	11
4.1.	Call Receipt	11
4.2.	Outline of Technology Options.....	13
4.2.1	Basic 9-1-1	13
4.3.	Enhanced 9-1-1	14
4.3.1	E9-1-1 Configuration Option 1: Bell Aliant Local Selective Router.....	15
4.3.2	E9-1-1 Configuration Option 2: Bell Aliant Remote Selective Router.....	16
4.4.	Next Generation 9-1-1	17
4.4.1	NG9-1-1 Configuration Option 1: Bell Aliant Local NG9-1-1 Selective Router	17
4.4.2	NG9-1-1 Configuration Option 2: Third Party NG9-1-1 Selective Router	18
4.5.	Summary and Comparison of Options	20
5.	Summary of Costs	22

5.1	Computer Telephony Integration.....	22
5.2	Wireline and Wireless Phone Estimates.....	24
5.3	Bell Aliant's Service Fee	25
5.4	Cost Recovery Fee	26
5.5	Annual Operating Costs	28
5.5.1	Basic 9-1-1	28
5.5.2	Enhanced and Next Generation 9-1-1.....	29
5.6	Staffing and Other Costs in a Province-wide Next Generation 9-1-1 System	32
5.6.1	Cost Recovery	34
6	Civic Addressing to Support an E9-1-1 or NG9-1-1 System (Location Based Data)	35
6.1	Intent.....	35
6.2	Location Fundamentals.....	35
6.2.1	Location Requirements for E9-1-1 Systems.....	37
6.3	Relevant Data Sources	39
6.3.1	Data Requirements.....	39
6.3.2	Available Data as a Basis for Civic Addressing or Responding Agency Geo-locating	40
6.3.2.1	NL Provincial Data sets.....	40
6.3.2.2	Other Data Sources	45
6.4	Data Structure.....	47
6.5	Data Gathering and Addressing Used by Other Entities.....	49
6.5.1	Newfoundland Power.....	49
6.5.2	Prince Edward Island (PEI).....	49
6.5.3	Nova Scotia	50
6.5.4	Maine.....	50
6.6	Feasibility Assessment	51
6.7	Recommendations Specific to Mapping and Addressing.....	53
7	Conclusion and Recommendation	55
8	Appendix A – References	56
9	Glossary	57
TABLE 1- SUMMARY OF CONFIGURATION OPTIONS		20
TABLE 2 - ESTIMATED NUMBER OF WIRELINE AND WIRELESS PHONES		25
TABLE 3 – PROJECTED ANNUAL SERVICE FEE REVENUE		25
TABLE 4 - INITIAL CAPITAL COSTS WITHOUT COMPUTER TELEPHONY INTERFACE		27
TABLE 5- INITIAL CAPITAL COSTS WITH COMPUTER TELEPHONY INTERFACE.....		27
TABLE 6 - POPULATION NOT COVERED BY BASIC WIRELINE 9-1-1		28
TABLE 7 - PER CAPITA CALL VOLUME		28
TABLE 8 - ANNUAL MAINTENANCE & LICENSE COSTS & RECURRING CHARGES WITHOUT COMPUTER TELEPHONY INTERFACE.....		30
TABLE 9 - ANNUAL MAINTENANCE & LICENSE COSTS & RECURRING CHARGES WITH COMPUTER TELEPHONY INTERFACE		30
FIGURE 1 (FIGURE 14 REPRODUCED) - NL 9-1-1 RELATED SALARIES, WAGES, & BENEFITS.....		X
FIGURE 2 (FIGURE 15 REPRODUCED) - HARDWARE CAPITAL COSTS.....		XI

FIGURE 3 (FIGURE 16 REPRODUCED) - CAPITAL EQUIPMENT.....	XI
FIGURE 4 (FIGURE 17 REPRODUCED) - RECURRING COSTS.....	XII
FIGURE 5 - RCMP B DIVISION OPERATIONAL COMMUNICATIONS CENTRE	4
FIGURE 6 - ROYAL NEWFOUNDLAND CONSTABULARY PSAP CORNER BROOK.....	4
FIGURE 7 - EXISTING BASIC WIRELINE 9-1-1 CONFIGURATION	11
FIGURE 8 - EXISTING BASIC MOBILE 9-1-1 CONFIGURATION.....	12
FIGURE 9 - PROVINCIAL CELLULAR COVERAGE.....	14
FIGURE 10 - ATLANTIC PROVINCES LEGACY E9-1-1 SELECTIVE ROUTER	16
FIGURE 11 - NEXT GENERATION 9-1-1 HOSTED BY BELL ALJANT	18
FIGURE 12 - NEXT GENERATION 9-1-1 THIRD PARTY HOSTED	19
FIGURE 13 - COMPUTERIZED TELEPHONY SCREEN.....	23
FIGURE 14 - NL 9-1-1 RELATED SALARIES, WAGES, & BENEFITS.....	32
FIGURE 15 - HARDWARE CAPITAL COSTS	33
FIGURE 16 - CAPITAL EQUIPMENT	33
FIGURE 17 - RECURRING COSTS.....	33
FIGURE 18 - DEGREES OF LATITUDE (NORTH-SOUTH) AND LONGITUDE (EAST-WEST)	36
FIGURE 19 - AN ASSISTED GPS SYSTEM.....	38
FIGURE 20 - GEOPLACE NAMES GEO-DATABASE INCLUDING RIVER/LAKE (A), FEATURES (B), PLACE NAMES (C).....	41
FIGURE 21 - GEOGRAPHIC EXTENT OF 2005-2010 AERIAL IMAGERY OVER NL	42
FIGURE 22 - SAMPLE OF A NL STRUCTURED COMMUNITY MAP	44
FIGURE 23 - MAPSNL ONLINE INTERFACE USED FOR DISPLAYING NL MAPPING DATA	44
FIGURE 24 - IMAGERY COVERAGE OF SUMMER MONTHS WITH <5% COLOUR COVER SINCE 2005 OVER NL.....	45
FIGURE 25 - RAPID EYE IMAGERY AVAILABLE FOR NORTH AMERICA.....	46
FIGURE 26 - LANDGAZETTE ONLINE INTERFACE USED FOR DISPLAYING AND DOWNLOADING NL SURVEY DATA.....	46
FIGURE 27 - FORMAT OF THE NEW BRUNSWICK 9-1-1 CIVIC ADDRESS LOCATION DATABASE.....	48
FIGURE 28 - ILLUSTRATION OF A RELATIONAL DATA MODEL FOR CIVIC ADDRESSES.....	48
FIGURE 29 - WEB-BASED INTERFACE FOR DOWNLOADING E9-1-1 ROADS DATA.....	50

I Summary, Observations, and Conclusions

The summary on the following 11 pages highlights the essential information found, in greater detail, within this report. We have offered subject references to the body of the report for those who might want more detailed information than can be found in this synopsis.

I.I Introduction and Purpose

The purpose of this report is to address the following subjects as part of an overall assessment of the feasibility of implementing a Basic or Enhanced 9-1-1 system in Newfoundland and Labrador:

- the purpose, advantages, and limitations of 9-1-1 systems;
- public expectations of emergency service response times within an operationalized 9-1-1 system;
- governance options;
- 9-1-1 legislation and regulations;
- the technical and operational call receipt and dispatch process;
- 9-1-1 technical architecture and solutions for a 9-1-1 system;
- staffing impact in a province-wide 9-1-1 environment; and,
- civic addressing including non-traditional geo-locating;

I.II Scope

9-1-1 systems, either basic or enhanced, do not include other components such as computer aided dispatch, mapping systems, geographic information systems, automatic vehicle locating, computer-telephony interfaces, radio systems, or other elements often associated, by the public and sometimes emergency responders, with 9-1-1. 9-1-1 systems stand by themselves although a suite of products, such as those noted in this paragraph, are often implemented at the same time as upgraded 9-1-1 systems. The purpose of Newfoundland and Labrador's study is to address the feasibility of a Basic or Enhanced 9-1-1 system in the province, which means that other components are out of scope although occasionally referenced. For example, Enhanced 9-1-1 can identify from where a call for emergency service originates but it does not provide other information such as road or access impediments and nearest water supply for firefighting, or whether an occupant of a household is physically impaired, weapons are located on the premises, or hazardous materials are located at the scene. Information such as that is stored in a geographic information system (GIS), computer aided dispatch system (CAD), or record management system (RMS). Since CAD, GIS, and RMS are not part of a Basic or Enhanced 9-1-1 system, and don't have a bearing on the feasibility of implementing Basic or Enhanced 9-1-1 in the province, they are not within the scope of this project.

Since 9-1-1 systems are not dependent upon other emergency services technology, emergency services organizations would not need to upgrade and enhance equipment in order for 9-1-1

service to be expanded. Nevertheless, we acknowledge that modern and accurate technology such as geographic information, CAD, and record management systems are immensely helpful to overall emergency services delivery.

I.III The Purpose of 9-1-1 and its Relationship to Emergency Response

The purpose of a 9-1-1 system is to facilitate the contact of emergency services. It is an easy to remember number known to almost everyone in Canada and the United States. Many of us have heard news stories where children as young as 4 or 5 have accessed 9-1-1 when a parent or caregiver has become ill or been injured. It is unlikely that those children would have been able to contact emergency services if it was necessary to find and dial a 7 or 10 digit number. In many parts of Newfoundland and Labrador access to emergency services is currently achieved by entering a 7 or 10 digit number on a telephone keypad.

In those parts of the province where 9-1-1 is not available, telephone numbers for police, fire, and emergency medical services may be prominently displayed in the community, or residents may have them noted near a telephone or other easy to find location in homes or businesses. Or they may even be programmed into telephones. In a circumstance when someone needs to place a call for assistance a resident would call the number for the type of emergency service they require and response would come from a designated police, fire, or emergency medical service. In some cases the designated service could be in the immediate community but, sometimes, help is sent from a neighboring community and a period of time, occasionally significant, could elapse before assistance arrives. Expansion of a 9-1-1 system will not affect the current police, fire, or ambulance travel time or from where assistance comes; in that respect, emergency response will not change because of the implementation of 9-1-1 (please see Section I.IV Public Expectations). What it will do is provide the public with easy access to a trained emergency services worker at anytime.

9-1-1 doesn't preclude someone from calling their local fire, ambulance or police detachment if they know the 7 or 10 digit emergency number but, if a house has to be evacuated in the middle of the night because of a fire and there is no time to find the number of the fire department; if a child is the only one who can call an ambulance and they can't read the 10 digit number or correctly dial it in the urgency of the moment; if a visitor to an area needs help or if a resident of the province is unsure which fire or ambulance service provides assistance to the area in which an incident has occurred; or if any one of us can't remember a local emergency number during the panic of an serious incident, 9-1-1 is available.

In addition to the easy access afforded by Basic 9-1-1, Enhanced 9-1-1 can provide location information and calling number identification.

I.IV Public Expectations

We performed an extensive review of articles, studies, and other research concerning public expectations for emergency service response times within a 9-1-1 system. The review included recent documentation on the increasing use of social media and technology during emergencies, and common public misperceptions.

Although we were unable to find any research that examined the specific topic of public expectations for service/response times within an operationalized 911 system, there were a number of studies and information pieces that, to various degrees, included public perceptions.

Three primary themes were identified in our review of public expectations. The public expects:

1. There will be access to emergency help regardless of location
2. Relevant, educated instructions will be provided during an emergency;
3. There will be a fast response to all calls (emergency & non-emergent).

Several misperceptions were identified during the review of literature, which highlight the public's higher expectations of technology and levels of service provision:

- The public assumes that PSAPs automatically know their location when they call
- The public assumes responders are qualified to handle their situation, and
- PSAPs have the ability to accept text information

In an on-line survey conducted by Intrado¹, in May of 2010 there was a definite disconnect between what the public expects from emergency 9-1-1 centers, and what the center and staff can actually deliver. Three main points were extracted from these results:

1. Almost everyone knows about 9-1-1;
2. A concerning number of people believe PSAPs can do more with information from cell phones than they actually can; and,
3. While landline use is decreasing, text-messaging use is increasing quickly (although 9-1-1 centers cannot yet accept text messaging).

Of the 2,000 citizens involved in the survey, 98% of respondents had knowledge of 9-1-1, and 76% believed the PSAP would know where they are calling from. Another 73% said they believed that 9-1-1 technology had the ability to find them if they could not speak. When asked to rank the most important ability of the PSAP to receive text messages, receive pictures, or pinpoint the caller's location, respondents overwhelmingly ranked location as the most important.

¹Intrado provides 911 operations support systems services to incumbent local exchange carriers, competitive local exchange carriers and wireless carriers.

The understanding of levels of training and capabilities of the responders and the PSAPs' staff are not highlighted as a priority for the general public in the reviewed documentation. There is an indication, however, that callers for emergency help assume they will receive the appropriate response and care they require when they call 9-1-1. For example, level of service availability – such as a primary care paramedic vs. an advanced care paramedic – is not completely understood by the general public. Consideration is not generally given to local staffing levels, whether a fire department is full-time or volunteer, the number of policing units in the area at a given time, etc.

The conclusion that we have drawn from studying public expectations is that, if the province decides to move ahead with a wider implementation of 9-1-1, extensive public education and expectation management must take place before a 9-1-1 system is expanded, and education must continue after implementation.

II 9-1-1 Technology Background

Basic 9-1-1, which is available in parts of Newfoundland and Labrador, is a three digit telephone number that is translated to a 7 or 10 digit number (sometimes known as call forwarding² and which is transparent to the caller), and routed to the closest Public Safety Answering Point (**PSAP**).

Enhanced 9-1-1 (E9-1-1) refers to the additional availability of Automatic Number Identification (**ANI**) and Automatic Location Identification (**ALI**). ANI is similar to the commercially available calling line identification available on home telephones, except that the caller cannot block the display of his or her number. Automatic Number Identification is used by telephone companies to reference the location of the telephone number and service; therefore, comprehensive civic addressing is a great advantage to E9-1-1 system effectiveness. Within this report, Enhanced 9-1-1 is also sometimes referred to as 'traditional Enhanced', or 'legacy Enhanced' to differentiate that technology from Next Generation 9-1-1 which could be considered a more robust type of Enhanced 9-1-1.

Next Generation 9-1-1 – In addition to the features provided by Enhanced 9-1-1, Next Generation 9-1-1 (NG9-1-1) prepares emergency services to keep pace with changing methods of communication and data transfer. Next Generation 9-1-1 enables communication via text messaging (including the transmission of text for the hearing impaired community), and allows the transmission of images, video and other data to a public safety answering point or emergency service. NG9-1-1 infrastructure is intended to replace the current services over time.

² Although the term "Call Forwarding" has been commonly used to describe the call processing of 9-1-1 dialed calls in the province, the actual "Line Feature" known as Call Forwarding, is not used or recommended for 9-1-1 as this method is not dependable. The 'call forwarding' line feature, is subject to accidental or event-related failures. The appropriate method is a Translation-encoded Instruction done at the telephone company switch level.

III Governance and Legislation

There are several definitions of governance but, for the purpose of this report, we have used the following:

Governance determines who has authority, who makes decisions, how other players make their voice heard and how accountability is rendered.

Governance models, within the scope of a province-wide 9-1-1 system, can be argued to be relatively restricted although operating models can be comparatively numerous. In a province-wide 9-1-1 system, authority and decision making must rest with the province or an agency designated by the province. The alternative is to let authority and decision making reside with municipalities, regions, or counties, which would result in a greater probability that the delivery of 9-1-1 would be inconsistent across the province. What would need to be determined, though, is the extent of governance that the province – either directly or through a designated agency – would assume. For example, should the province restrict its role to setting enabling legislation and regulations and monitoring of compliance, but leave the implementation of 9-1-1 (within the legislation and regulations) to local and regional municipalities? Or should the province take the lead in such things as directly operating or contracting 9-1-1 Public Safety Answering Points, assuming responsibility for municipal addressing standards, and setting qualifications for 9-1-1 staff? However, the consideration of whether the province should be involved in directly operating or contracting PSAPs moves away from governance and into operations.

So, governance, in a province-wide 9-1-1 system, almost dictates that decision making and authority rest with the province or a provincial agency, which is our recommendation for Newfoundland and Labrador. The alternative is to have a decentralized 9-1-1 system, such as in Ontario, British Columbia and most of the United States, where authority, and therefore governance, rests at the municipal or county level. This model can be successful in urban areas or where a county or region takes on responsibility for 9-1-1, but may not be as efficacious in lightly populated or unincorporated areas. In such cases, access to 9-1-1 may be inconsistent and contrary to the philosophy of province-wide availability.

We conducted a review of various 9-1-1 models across Canada, and the associated governance structures, but found the models in the maritime provinces to be most relevant to Newfoundland and Labrador. (Please see Section 3 of the report).

Therefore, our recommendation is to establish a centralized 9-1-1 Bureau, similar to those found in the other Atlantic Provinces, to ensure the uniform application of policy, technology, and operations in Newfoundland and Labrador.

IV Technology Options

IV.I Basic 9-1-1

In a majority of cases, Basic 9-1-1 provides connection to an emergency call answer center via a protected network of dedicated trunk lines, but Basic 9-1-1 doesn't provide enhanced features that many people associate with 9-1-1, such as Automatic Number Identification and selective routing. Selective routing is the process by which 9-1-1 calls are sent to a specific PSAP based on the street address of the caller and is further described in Section 4.3. Instead of using selective routing, Basic 9-1-1 routes calls to the appropriate 9-1-1 public safety answering center based on the location of the originating telephone central office only.

However, with the Basic 9-1-1 configuration that is currently in place in Newfoundland and Labrador (Corner Brook, Labrador City, and St. John's), Bell Aliant does not use dedicated trunk lines but has provided central office translations to route 9-1-1 dialed calls to a 7 digit number that terminates at the appropriate PSAP. There is no indication to a caller that the call they placed by dialing 9-1-1 is being redirected to a 7 or 10 digit number.

In order to cover those areas of the province that don't have wireline 9-1-1 service, this form of basic 9-1-1 could be extended by providing the central office translations to a toll free number(s) that terminates at the appropriate PSAP. In addition, where the functionality is available in the telephone company's central office switch, the calling line number and/or number associated with the voice call would be forwarded to the PSAP. However, the identification of the calling number would be available only as residential grade Calling Line Identification (CLID) but not as Enhanced 9-1-1 Automatic Number Identification (ANI), which means it is only revealed if the customer has agreed to do so. In cases where a telephone customer has elected not to have their telephone number displayed, or decides to block it by entering a blocking code before calling 9-1-1, a telephone number would not be displayed. Enhanced 9-1-1 will display a caller's telephone number even if he or she has tried to block it.

A translated number configuration is not as robust as a traditional Basic 9-1-1 implementation since there are no dedicated trunk lines and no redundant paths from the central offices to the PSAPs. This means that 9-1-1 is no more or less susceptible to service outages as the balance of the telephone infrastructure. Nevertheless, given that 9-1-1 translation is the method currently and historically used by Bell Aliant to access existing PSAPs in Newfoundland and Labrador a translated 9-1-1 configuration is a reasonable and workable method for extending 9-1-1 to other areas of the province. A long term goal would be to implement Enhanced or Next Generation 9-1-1 service, which would include engineered 9-1-1 telephone circuits with appropriate cable and power supply redundancies,

We have found that extending Basic 9-1-1 service to the balance of the province, using number translation technology, is a practical interim measure that can be introduced at low cost. Nevertheless, a plan would have to be put in place to ensure the existing

PSAPs are prepared with adequate mapping and, possibly, telephone configurations to accept 9-1-1 calls from a wider area. We expect, at the early and even mid stages of an expanded 9-1-1 initiative, that there would be minimal or no impact on current staffing and technology at the PSAPs.

IV.II Enhanced and Next Generation 9-1-1

There are several technology options to be considered if the province decides to implement an Enhanced or Next Generation 9-1-1 strategy.

IV.II.I E9-1-1 Configuration Option 1: Bell Aliant Local Selective Router

Option 1 would include new 9-1-1 software installed on the Bell Aliant switch at the Allandale central office which would be the Primary 9-1-1 Selective Router for Newfoundland. However, the selective router software was originally developed by Nortel, and this part of Nortel's assets was purchased by a company named GENBAND which will not sell new E9-1-1 Selective Router software for the switch type in use at the Allandale Central Office. As well, even if new software could be accessed, GENBAND will not provide support after 2013. Additionally, Bell Aliant staff in Newfoundland and Labrador would have to be trained to maintain the software, which may not be a prudent use of resources considering that support will be ended by the vendor.

IV.II.II E9-1-1 Configuration Option 2: Bell Aliant Remote Selective Router

The second option would be to have the 9-1-1 service hosted by existing selective routers in another province. This option has some challenges including the cost of connectivity from Newfoundland and Labrador PSAPs to and from the host switching centers, which might be in Fredericton and Moncton, New Brunswick (please see Figure 10). The connectivity model would need to include a redundant path in case of failure of the primary link, and the cost of these connections often increase with distance. Also, there may be issues related to technological incompatibility that would need to be overcome by additional engineering, or the provision of interfacing technology with the PSAPs.

IV. II.III NG9-1-1 Configuration Option 1: Bell Aliant Local NG9-1-1 Selective Router

The first option would be to have the 9-1-1 service hosted by two new NG9-1-1 Selective Routers in the Bell Aliant central offices located in St. John's and Corner Brook

IV.II.IV NG9-1-1 Configuration Option 2: Third Party NG9-1-1 Selective Router

The second option would be to have the 9-1-1 service hosted by two new NG9-1-1 Selective Routers but operated by a third party (non-telephone company or organization). The routers could be housed in the third party operator's facilities in St. John's and Corner Brook, in government buildings, or another acceptable location.

V Civic Addressing

(Please see Section 6)

An Enhanced 9-1-1 system (either traditional enhanced or next generation) requires civic addressing to function. Without civic addressing, no matter how robust the telephone or PSAP technology, calls for assistance from a wireline telephone would not transmit an address. Therefore, an important part of preparing for an enhanced system will be ensuring accurate civic addressing.

A key spatial data layer required for E9-1-1 services is a road centerline network with civic addresses. The road centerline network for the province exists but requires updating to include existing municipal roads and to identify private roads. Currently, from a mapping perspective, the province does not maintain any changes to municipal roads. Updating would require the allocation of new resources to fund the digital mapping of these newer roads. The effort for this is expected to be on the order of 3-5 months of mapping work. However, only a partial unmaintained civic addressing data set exists with the centerline road file. Civic addressing data would need to be rebuilt to conform to a more comprehensive data model. As well, rural areas would need to be added to the database. Creating civic addresses for all rural areas of Newfoundland and Labrador is an undertaking that would require a significant investment of resources as such an initiative would involve selecting and approving appropriate standards and data models as well as building and validating the data. There are technical and political challenges to consider as well, such as resolving road naming issues across NL communities and rural areas that do not have civic addresses. The implication is that locations of residences would need to be acquired by building a mapping data set through either a GPS-based data collection program and/or extraction of location data from orthoimagery.

Creating an initial civic mapping data set that would make use of existing civic address data, augmented with data collected from unincorporated areas, would likely take 7 to 14 months to build an initial version. However, it would realistically take at least 3 years to improve the accuracy and reliability of the system, and to resolve all data-related civic addressing issues and gaps. Although this process may take several years, it should not be considered a deterrent to establishing an E9-1-1 system across NL but should rather be considered as a building process that will provide wider government benefits from this data set. The E9-1-1 system could be rolled out using a priority-sequenced process, building the mapping data sets in geographic stages at a community or regional level.

Previous attempts in the mid-1990s to implement a 9-1-1 system were impeded by the lack of infrastructure, geospatial data availability (i.e. civic addressing) and costs¹. Today, lack of mapping data is not as much of a limitation as it was during the 1990s since more data is now available that can be repurposed for emergency 9-1-1 applications. Furthermore, technological advancements have made supporting E9-1-1 through web mapping services more cost effective and efficient as well.

We have found that the foundation mapping data to support E9-1-1 in Newfoundland and Labrador is available and could be assembled rapidly with the allocation of additional resources. Additional significant net benefits would also be created beyond E9-1-1 applications. We have taken into account funding for additional resources in our cost calculation.

VI Staffing and Other Costs

We have had to make some assumptions in order to come up with a cost estimate for the implementation of Enhanced or Next Generation 9-1-1 throughout the province. Readers should note that these estimates could vary significantly from a final tally, however, further investigation and the involvement of various government departments and stakeholders will refine the approximations discussed in this section.

To estimate capital costs for the implementation of a full featured 9-1-1 system in Newfoundland and Labrador we used the estimate based on a Next Generation configuration, since that will require the greatest initial investment, although possibly resulting in the most robust configuration. So, capital costs for 9-1-1 equipment are estimated at \$1.38 million (Table 5 in Section 5.4).

We have also used an estimate, based on a Next Generation configuration, to estimate annual maintenance of the 9-1-1 system. Therefore, annual maintenance of a province wide NG9-1-1 system is estimated at approximately \$295,000 (Table 9 in Section 5.5).

Salaries, wages, and benefit (SW&B) costs, shown in Figure 14 (reproduced below), are based on costs from projects we have conducted in other jurisdictions but may be overestimated compared to actual SW&B in Newfoundland & Labrador.

Figure 1 (Figure 14 Reproduced) - NL 9-1-1 Related Salaries, Wages, & Benefits

PSAP Staff Increases (based on 2085 hours per year/FTE)		Absence Replacement Hours	Estimated Hourly Rate	SW&B + Absence Replacement	Benefits @ 28% of Regular Wages	Total Annual Cost
St. John's Regional Fire Department	2085.60	702	\$34.50	\$96,179.17	\$26,930.17	\$123,109.34
RCMP B Division	5840	2169	\$34.50	\$276,300.29	\$77,364.08	\$353,664.37
RNC Corner Brook	2086	775	\$34.50	\$98,678.67	\$27,630.03	\$126,308.70
RNC Labrador City	0	0	\$34.50	\$0.00	\$0.00	\$0.00
9-1-1 Bureau staff						
	Complement		Annual S&W	Result	Benefits @ 28% of Regular Wages	Total Annual Cost
Bureau Director	1		\$125,000	\$125,000	\$35,000.00	\$160,000.00
IT / Telephony Staff	2		\$68,988	\$137,976	\$38,633.28	\$176,609.28
Civic Addressing - Mapping	1		\$68,988	\$68,988	\$19,316.64	\$88,304.64
Administrative Support	1		\$44,417	\$44,417	\$12,436.76	\$56,853.76
GIS and IT Support Other Provincial Departments						
	Complement			Annual S&W	Benefits @ 28% of Regular Wages	Total Annual Cost
GIS Staff	2		\$68,988	\$137,976	\$38,633.28	\$176,609.28
IT Staff	1		\$68,988	\$68,988	\$19,316.64	\$88,304.64
Total Annual Staff Commitment						\$1,349,764

Hardware, recurring charges (map, software, and data purchases), and other capital costs to support a province-wide NG9-1-1 system are estimated at \$217,560 (Figure 15 reproduced below).

Figure 2 (Figure 15 Reproduced) - Hardware Capital Costs

Hardware Capital Costs			
GIS Servers	\$27,356	Basic hardware support included	
Storage	\$40,000		
Software	Assumed that the province has GIS software		
Mapping purchases (satellite & conventional)	\$100,000		
Sub-Total	\$167,356		
Contingency 30%	\$50,207		
Total	\$217,563		

A facility of approximately 110 square meters to house the 9-1-1 Bureau, assuming space was not available in government facilities, could require a capital investment of \$220,000 (land costs not included) with operating costs of approximately \$6,600 a year (calculated at 3% of capital costs). Alternatively, leasing acceptable space would require about \$24,000 a year.

So, we calculate that to set up a 9-1-1 Bureau, ensure adequate support from other government departments, purchase and maintain hardware and software, and enhance staff levels at the 4 PSAPs to accept increased call volume, will require a capital investment of approximately \$1.5 million and annual costs of \$1.8 million upon full implementation. This staffing configuration may take several years to put into full effect depending upon the speed of Basic 9-1-1 roll out and eventual NG9-1-1 implementation.

Figure 3 (Figure 16 Reproduced) - Capital Equipment

PSAP capital equipment	\$1,150,774
Contingency (20%)	\$230,155
GIS Servers	\$27,356
Storage	\$40,000
Contingency 30%	\$50,207
Total Capital Investment	\$1,498,492

In addition to the Total Capital Investment of \$1,498,492, an accrual of \$500,000 needs to occur annually to replace the capital equipment on a 3 year evergreen cycle. ($\$1,498,492 / 3 = \$499,497$).

Figure 4 (Figure 17 Reproduced) - Recurring costs

Mapping purchases (satellite & conventional)	\$100,000
Toll Free Charges	\$22,615
Annual Maintenance	\$82,938
ALI/LIS Database License	\$195,463
Contingency (20%)	\$16,588
Facility Lease	\$24,000
Annual Staff Costs	\$1,349,764
Total Recurring Costs	\$1,791,368

It's possible that toll free charges may eventually disappear with full E9-1-1 or NG9-1-1 implementation.

VI.I Cost Recovery

Considering that there are estimated to be 231,000 land line telephones and 377,844 wireless phones in Newfoundland and Labrador,

- and if a decision was made to recover costs – either via the telephone company or the province – based upon a monthly fee per telephone line or subscription;
- and if a 3 year evergreen cycle was instituted for the PSAP capital equipment (Figure 3 and Figure 16)
- then \$2.3 million per year would have to be recovered to fund a provincial E9-1-1 system.

That translates to \$0.31 per telephone line or subscription. In addition, depending on the Enhanced or Next Generation 9-1-1 option that may be chosen, Bell Aliant may approach the Canadian Radio-television Telecommunications Commission to revise their tariff to allow for a service fee related to establishing and maintaining a 9-1-1 network. In other provinces that tariff has been approved at between 25 cents to 35 cents per month per telephone line. It is possible, therefore, that a combined cost recovery and service fee could amount to approximately 66 cents per month.

VII Conclusion and Recommendation

Readers might surmise, based on the content of this report, that the province could quickly expand the existing 9-1-1 system to other areas of the province and then proceed with the implementation of Enhanced 9-1-1. From a purely technical perspective that is possible; but from the perspective of best practice, project management, and optimal delivery of 9-1-1 to the public, that would be an erroneous method of proceeding.

Instead, the province's next step – if it proceeds with expanded 9-1-1 – is to strike a senior level working group to further define a plan for 9-1-1 implementation. Other steps should include the following:

- Schedule a facilitated session of the working group to explore the steps and duration required to expand 9-1-1 in the province. Topics of discussion should include legislation, governance, regulations, organization, administration, operations, and an implementation process.
- Determine the lead or primary Department for provincial 9-1-1 activities and authority.
- Determine a governance structure.
- Draft and enact legislation authorizing governance and the activities of a provincial 9-1-1 Bureau.
- Create and staff a 9-1-1 Bureau under the auspices of the responsible Department.
- Initiate a province-wide 9-1-1 education program so that residents understand the purpose, capabilities and limitations of a 9-1-1 system.

We recommend that the province's next step is not to expand the existing 9-1-1 system, but to initiate a planning group to put in place the steps described immediately above.

In conclusion, we find that a cautious, progressive, and planned implementation of Basic 9-1-1 and, eventually, a multi-year plan resulting in the implementation of Next Generation 9-1-1 throughout Newfoundland and Labrador is quite feasible at an estimated (based on what we know at this time), equivalent of less than \$0.75 per month per telephone line or wireless subscription.

1. Introduction and Purpose

The purpose of this report is to address the following subjects as part of an overall assessment of the feasibility of implementing a Basic or Enhanced 9-1-1 system in Newfoundland and Labrador:

- the purpose, advantages, and limitations of 9-1-1 systems;
- public expectations of emergency service response times within an operationalized 9-1-1 system;
- Governance options;
- 9-1-1 legislative and regulatory options;
- Technical and operational call receipt and dispatch process;
- Various options for 9-1-1 technical architecture and solutions for a 9-1-1 system in Newfoundland and Labrador;
- Staffing impact in a province-wide 9-1-1 environment; and,
- Civic addressing including non-traditional geo-locating;

1.1. Scope

9-1-1 systems, either basic or enhanced, do not include other components such as computer aided dispatch, mapping systems, geographic information systems, automatic vehicle locating, computer-telephony interfaces, radio systems or other elements often associated, by the public and sometimes emergency responders, with 9-1-1. 9-1-1 systems stand by themselves although a suite of products, such as those noted in this paragraph, are often implemented at the same time as upgraded 9-1-1 systems. The purpose of Newfoundland and Labrador's study is to address the feasibility of a 9-1-1 or Enhanced 9-1-1 system (including Next Generation 9-1-1), in the province, which means that other components are out of scope although occasionally referenced.

2. Background

2.1. 9-1-1 Technology

Basic 9-1-1, which is available in parts of Newfoundland and Labrador, is a three digit telephone number that is, to all intents and purposes, translated to a 10 digit number (sometimes known as call forwarding³ and which is transparent to the caller) and routed to the closest Public Safety Answering Point (**PSAP**).

Enhanced 9-1-1 refers to the additional availability of Automatic Number Identification (**ANI**) and Automatic Location Identification (**ALI**). ANI is similar to the commercially available calling line identification available on home telephones, except that the caller cannot block the display of his or her number. Automatic Number Identification is used by telephone companies to reference the location of the telephone number and service, therefore, comprehensive civic addressing is a great advantage to 9-1-1 system effectiveness.

In addition to the features provided by Enhanced 9-1-1, **Next Generation 9-1-1 (NG9-1-1)** prepares emergency services to keep pace with changing methods of communication and data transfer. Next Generation 9-1-1 enables communication via text messaging (including the transmission of text for the hearing impaired community), and allows the transmission of images, video and other data to a public safety answering point or emergency service. NG9-1-1 infrastructure is intended to replace the current services over time. The National Emergency Number Association (NENA) first identified the need for NG9-1-1 in 2000, and started development actions in 2003, and is nearing full definition and standards for NG9-1-1.

The Canadian Radio-television Telecommunications Commission (CRTC) has specified requirements for cellular providers to ensure that cell phones are compatible with enhanced 9-1-1 service. These have been implemented in two phases:

- Phase I requires a wireless 9-1-1 call to be associated with a valid call-back number (the caller's cell phone number will show up at the public safety answering point) and provision of the cell site/sector from which the call originated. The intent is to help ascertain the general location of the caller but in reality it may only be useful to help determine where to route a call when it is coming in near the border of emergency service providers.
- Phase II adds the requirement of locating the cellular caller to within 50 to 100 meters of the caller's location. Location information is sent to a PSAP as latitude/longitude coordinates which can be then displayed on a Computer Aided Dispatch (**CAD**)

³ Although the term "Call Forwarding" has been commonly used to describe the call processing of 9-1-1 dialed calls in the province, the actual "Line Feature" known as Call Forwarding, is not used or recommended for 9-1-1 as this method is not dependable. The 'call forwarding' line feature, is subject to accidental or event-related failures. The appropriate method is a Translation-encoded Instruction done at the telephone company switch level.

geographic information system display (**GIS**) display and extrapolated to a civic address where available. A more complete explanation can be found in Section 6.1.

The intent of this section is to provide information as to whether data exists to enable the province to establish civic addressing of sufficient quality to support an Enhanced or Next Generation 9-1-1 system. We found existing geographic data to be more than adequate for this purpose.

2.2. Location Fundamentals

Basic 9-1-1 services are currently available via conventional **wireline**⁴ and cell phone in:

- North East Avalon and the St. John's area where the Public Safety Answering Point (PSAP) is operated by the St. John's Regional Fire Department;
- Corner Brook / Bay of Islands where the PSAP is operated by the Royal Newfoundland Constabulary;
- Labrador City and Wabush, also operated by the Royal Newfoundland Constabulary; and,
- anywhere else in the province, where mobile coverage is available, callers can dial 9-1-1 and be connected to the appropriate PSAP even though 9-1-1 may not be available through conventional wireline because the wireline number is outside the catchment area of the PSAPs noted above.

2.3. Infrastructure and Organizational Resources

The **St. John's Regional Fire Department** is the PSAP for the North East Avalon. The center includes four console positions and a supervisory position located just outside the main communications room. Two of the four positions are staffed on a regular basis which, at this time, is adequate to handle the volume of 9-1-1 calls received as well as regular call taking and dispatching duties for the St. John's Regional Fire Department.

The **RCMP Operational Communications Centre (OCC)** in St. John's is a conventional RCMP communications facility housed in a compact but adequate space at B Division headquarters. This OCC acts as the provincial PSAP for all cellular calls to 9-1-1 from locations not served by the RNC or St. John's Regional Fire Department PSAPs. The OCC is staffed by several communications personnel, the number of which is dependent upon historical call volume based upon the day of week and time of day. As well, the RCMP provides both supervisory and management oversight for the OCC.

⁴ Mention of 'wireline' includes other voice technology dependent upon a physical connection to function, such as voice over internet protocol (VoIP) telephones. Telephone companies sometimes refer to VoIP as digital connections.

Figure 5 - RCMP B Division Operational Communications Centre



The Royal Newfoundland Constabulary's PSAPs in Corner Brook and Labrador City are staffed by one person each shift. In addition to call taking and dispatching duties, that person provides support to the RNC members on duty and manages both telephone and walk-in inquiries from the public.

Figure 6 - Royal Newfoundland Constabulary PSAP Corner Brook



2.4. Public Expectations of 9-1-1

We performed an extensive review of articles, studies, and other research concerning public expectations for emergency service response times within a 9-1-1 system. The review included recent documentation on the increasing use of social media and technology during emergencies, and common public misperceptions.

Although we were unable to find any research that examined the specific topic of public expectations for emergency service response times within an operationalized 911 system, there were a number of studies and information pieces that, to various degrees, included public perceptions.

Three primary themes were identified in our review of public expectations. The public expects:

1. There will be access to emergency help regardless of location.
2. Relevant, educated instructions will be provided during an emergency.
3. There will be a fast response to all calls (emergency & non-emergent).

Several misperceptions were identified during the review of literature, which highlight the public's higher expectations of technology and levels of service provision:

- The public assumes that PSAPs automatically know their location when they call.
- The public assumes responders are qualified to handle their situation, and,
- PSAPs have the ability to accept text information.

In an on-line survey conducted by Intrado⁵, in May of 2010 there was a definite disconnect between what the public expects from emergency 9-1-1 centers, and what the center and staff can actually deliver. Three main points were extracted from these results:

4. Almost everyone knows about 9-1-1;
5. A concerning number of people believe PSAPs can do more with information from cell phones than they actually can; and,
6. While landline use is decreasing, text-messaging use is increasing quickly (although 9-1-1 centers cannot yet accept text messaging).

Of the 2,000 citizens involved in the survey, 98% of respondents had knowledge of 9-1-1, and 76% believed the PSAP would know where they are calling from. Another 73% said they believed that 9-1-1 technology had the ability to find them if they could not speak. When asked to rank the most important ability of the PSAP to receive text messages, receive pictures, or pinpoint the caller's location, respondents overwhelmingly ranked location as the most important.

⁵Intrado provides 911 operations support systems services to incumbent local exchange carriers, competitive local exchange carriers and wireless carriers.

Understanding levels of training and capabilities of emergency responders and PSAPs' staff are not highlighted as a priority for the general public in the reviewed documentation. There is an indication, however, that people who call 9-1-1 assume they will receive the appropriate response and care. For example, level of service availability – such as a primary care paramedic vs. an advanced care paramedic – is not completely understood by the general public. Nor is consideration generally given to local staffing levels, whether a fire department is full-time or volunteer, the number of policing units in the area at a given time, etc.

In those parts of the province where 9-1-1 is not available, telephone numbers for police, fire, and emergency medical services may be prominently displayed in the community, or residents may have them noted near a telephone or other easy to find location in homes or businesses. Or they may even be programmed into telephones. In a circumstance when someone needs to place a call for assistance a resident would call the number for the type of emergency service they require and response would come from a designated police, fire, or emergency medical service. In some cases the designated service could be in the immediate community but, sometimes, help is sent from a neighboring community and a period of time, occasionally significant, could elapse before assistance arrives.

Notwithstanding the possible public expectation that 9-1-1 will result in a fast response to all calls, expansion of a 9-1-1 system will not affect the current police, fire, or ambulance travel time or from where assistance comes. In that respect, emergency response will not change because of the implementation of 9-1-1. What it will do is provide the public with easy access to a trained emergency services worker at anytime.

The conclusion that we have drawn from studying public expectations is that, if the province decides to move ahead with a wider implementation of 9-1-1, extensive public education and expectation management must take place before a 9-1-1 system is expanded, and education must continue after implementation.

3. Governance and Legislation

3.1. Governance

There are several definitions of governance but, for the purpose of this section we have used the following:

Governance determines who has authority, who makes decisions, how other players make their voice heard and how account is rendered.

Governance models, within the scope of a province-wide 9-1-1 system, can be argued to be relatively restricted although operating models can be comparatively numerous. In a province-wide 9-1-1 system, authority and decision making must rest with the province or an agency designated by the province. The alternative is to let authority and decision making reside with municipalities, regions, or counties, which would result in a greater probability that the delivery of 9-1-1 would be inconsistent across the province. What would need to be determined, though, is the extent of governance that the province – either directly or through a designated agency – would assume. For example, should the province restrict its role to setting enabling legislation and regulations and monitoring of compliance, but leave the implementation of 9-1-1 (within the legislation and regulations) to local and regional municipalities, or should the province take the lead in such things as directly operating or contracting 9-1-1 Public Safety Answering Points, assuming responsibility for municipal addressing standards, and setting qualifications for 9-1-1 staff? However, the consideration of whether the province should be involved in directly operating or contracting PSAPs moves away from governance and into operations.

So, governance, in a province-wide 9-1-1 system, almost dictates that decision making and authority rests with the province or a provincial agency, which is our recommendation for Newfoundland and Labrador. The alternative is to have a decentralized 9-1-1 system, such as in Ontario, British Columbia and most of the United States, where authority, and therefore governance, rests at the municipal or county level. This model can be successful in urban areas or where a county or region takes on responsibility for 9-1-1, but may not be as efficacious in lightly populated or unincorporated areas. In such cases, access to 9-1-1 may be inconsistent and contrary to the philosophy of province-wide availability.

We conducted a review of various 9-1-1 models across Canada and the associated governance structures, but found the models in the other Atlantic provinces to be most relevant to Newfoundland and Labrador. These include:

New Brunswick:

- In New Brunswick, 9-1-1 centers are operated directly by the province through the New Brunswick 9-1-1 Bureau, which manages the ongoing operations of the service, the

management of all records associated with the program, and civic addressing for unincorporated areas of the province.

- The 9-1-1 Bureau falls under the jurisdiction of the Department of Public Safety, Emergency Services Branch. The Branch coordinates intra and intergovernmental policy matters in the areas of emergency management, emergency response and interoperability, which is effected through governance, policy and technology.
- The Emergency 9-1-1 Act requires mandatory billing, collection and remittance of subscriber fees to the NB 9-1-1 Service Fund by all telecommunication service providers. The NB 9-1-1 Service Fund (\$0.53 per subscriber) supports costs associated with 9-1-1 services in New Brunswick.
- In 2009, the total call volume for 9-1-1 calls exceeded 168,000, a 2% increase from the previous year.
- Currently, there are six Public Safety Answering Points (PSAPs) around the province, located in Saint John, Edmundston, Fredericton, Moncton, Bathurst and Miramichi. The RCMP provides service to the remainder of the province.
- There are existing partnerships with Aliant Mobility and KML Technology Computer Telephony System Integrator.
- The Emergency Telecommunication Services Program is now offered at CCNB – Dieppe Campus.
- A 9-1-1 Technological Enhancement Project was initiated at the Public Safety Answering Points (PSAPs) and the NB 9-1-1 Bureau which enhanced communication tools and established network links between the six PSAPs. Standards are being identified in order to improve services and technology and to add new features and functionality to 9-1-1 (i.e. enabling texting to 9-1-1). The NB 9-1-1 Bureau is working with the CRTC Emergency Services Working Groups of 9-1-1 industry stakeholders to reach consensus and achieve the goals and objectives of the Next Generation 9-1-1 standards and expectations.
- Civic addressing is provided through the local organized municipalities, with the 9-1-1 Bureau managing civic addressing for unincorporated areas of the province.
- Applicable legislation is the Emergency 9-1-1 Act, and the New Brunswick General Regulation 96-104 under the Emergency 9-1-1 Act.

Nova Scotia:

- In Nova Scotia, 9-1-1 emergency service is administered by the Emergency Management Office (EMO), a division of the Department of Justice, which provides all training, specialized computer software and standard operating procedures for the 9-1-1 centers.

- Currently there are four PSAPs located in the province, involving both public and privately operated emergency dispatch centers which handle approximately 180,000 calls per year. In the fiscal year of 2009/10, 53% of all calls received were by landlines, with 47% received from cellular phones. PSAPs are operated by the Halifax Regional Municipality, Cape Breton Regional Municipality, Truro and Kentville.
- There are existing partnerships with the Halifax Regional Municipality, RCMP, and Cape Breton Regional Municipality; communication partnerships with Bell Aliant, Valley Communications, Eastlink Communications, Seaside Communications, as well as cellular providers, Bell Mobility, Telus, Rogers Wireless and Virgin Mobile.
- Nova Scotia's 9-1-1 system was implemented in 1997. In February 2010, Nova Scotia achieved the ability to locate cellular calls with latitude/longitude coordinates, referred to as Phase II Wireless. This was achieved with representatives from Nova Scotia's EMO office working on a national committee, the 9-1-1 software vendor and the province's mapping specialists at the Nova Scotia Geomatics Center.
- In 2009-10, EMO constructed a new state-of-the-art call taker training facility.
- Civic addressing is assigned and managed at the local municipal level. EMO is responsible to notify local exchange carriers (i.e., Aliant & EastLink) of any updates or changes reported. This information is supplemented, stored and managed with a central geo-referenced database referred to as the Nova Scotia Civic Address File (NSCAF).
- Applicable legislation is the Emergency "9-1-1" Act, and the Emergency 9-1-1 Cost Recovery Fee Regulations made under Section 14 of the Emergency "9-1-1" Act (N.S. Reg. 8/2001).

Prince Edward Island:

- In PEI, the 9-1-1 Administration Office is part of the Department of Justice and Public Safety, and acts as the coordinating agency for the operation of the E9-1-1 service.
- The province of Prince Edward Island with Island Telecom Inc., entered into a Memorandum of Understanding with the cities of Charlottetown and Summerside, and the RCMP, to implement a 9-1-1 Emergency Response System (ERS).
- There are currently three (3) PSAPs, located in the cities of Summerside and Charlottetown police departments, and the RCMP, which provides police services to the remainder of the province. In 2009/10, there were approximately 27,850 emergency calls received by the 3 PSAPs. This represented a 5.4% increase (26,400) from the prior year, 2008/09.
- There are existing partnerships with Combix Inc., a supplier of specialized 9-1-1 software, and Aliant. PEI has also partnered with Holland College to provide communication training sessions for all PSAP managers and call-takers.
- In February 2010, Prince Edward Island implemented Wireless Phase II for emergency 9-1-1 calls.

- The 9-1-1 Administration Office plays a lead role in maintaining the provincial civic addressing database, with co-operative arrangements having been established with 17 municipalities, enabling them to report addressing changes directly to the 9-1-1 Administration Office.
- The applicable legislation is the Emergency 9-1-1 Act.

3.2. Legislation

If Newfoundland and Labrador decides that it is reasonable to move ahead with a provincial 9-1-1 system the province, as others, would likely develop and implement appropriate legislation which would include the chosen governance model. Once a designated government division is identified to provide the oversight of 9-1-1 systems and operations, the Minister of the appropriate division would be identified as the authority within the legislation. For example, in New Brunswick, authority is within the jurisdiction of the Minister of Public Safety; in Nova Scotia, the authority lies with the Minister of Justice; and in PEI, it is the Minister responsible for Environment, Labor and Justice.

Areas that should be included in the legislation and regulations are:

- Purpose of the Act;
- Definitions/Interpretations;
- Administration of the Act (identifying who has designated authority);
- Responsibilities of the designated authority (including agreements for development, establishment and operation of a 9-1-1 service; administration of policies, standards, guidelines, objectives, codes of practice, etc.);
- Agreements with telecommunications carriers;
- Agreements with municipalities and emergency service providers;
- Cost recovery fee arrangements and delegations;
- Restriction on information supplied (such as the design, development, implementation, operation and maintenance of a 9-1-1 system);
- Application of certain provisions;
- Exemption and protection from liability;
- Prohibitions (such as the programming of 9-1-1 into speed dial on phones);
- Offences and penalties (e.g. misuse of the 9-1-1 service);
- Regulations or Schedules (i.e., Cost Recovery Fee amount);
- Civic Addressing clause (i.e., who is responsible, municipal obligations, standards, etc.);
- Amendments required to other legislation (i.e., Municipal Act).

4. 9-1-1 Technology and Operations

4.1. Call Receipt

There are four PSAPs in the province that receive 9-1-1 calls:

- St. John's Regional Fire Department, responsible for the Northeast Avalon area;
- RCMP "B" Division, responsible for the rural communities and highway patrol, which receives rural 9-1-1 mobile calls.
- Corner Brook Royal Newfoundland Constabulary, responsible for Corner Brook, Humber Valley and Bay of Islands; and,
- Labrador West Royal Newfoundland Constabulary, responsible for Labrador City and Wabush.

The 9-1-1 call routing for these centers is outlined in Figure 7 and 8.

Figure 7 - Existing Basic Wireline 9-1-1 Configuration

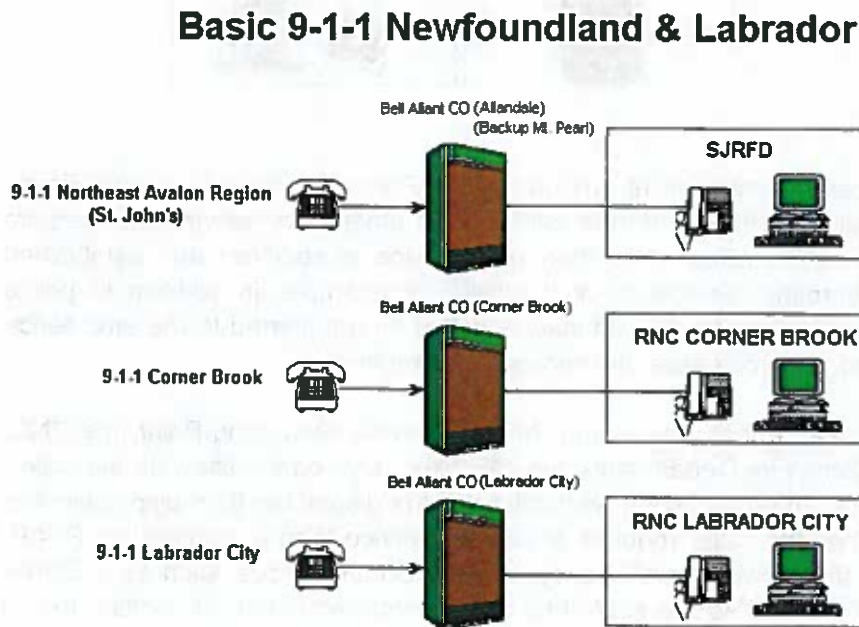
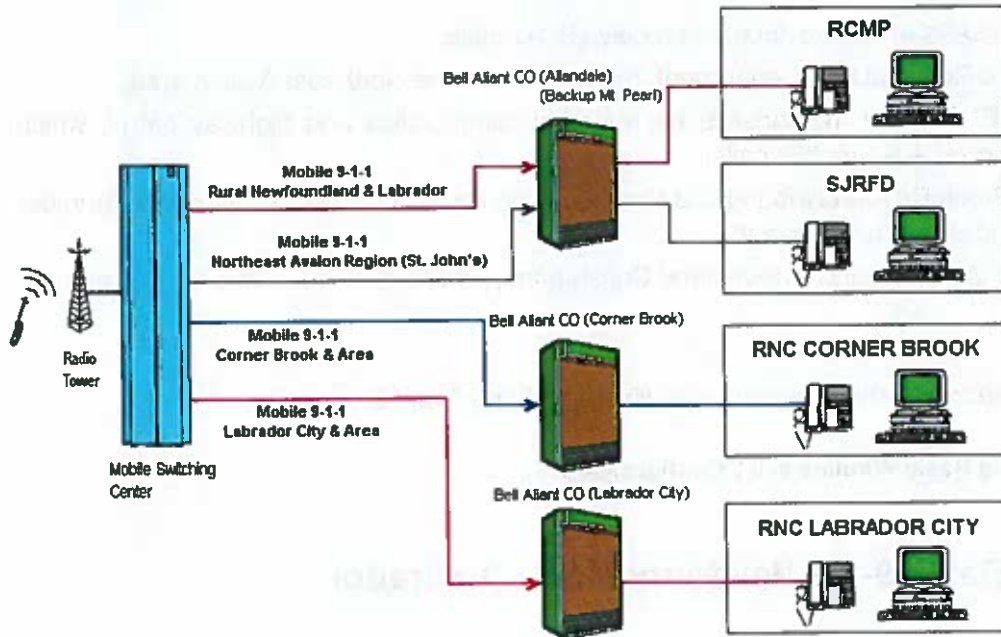

Figure 8 - Existing Basic Mobile 9-1-1 Configuration

Basic Mobile 9-1-1 Newfoundland & Labrador



Currently, when a 9-1-1 call is answered at any one of the Primary Safety Answering Points (PSAPs), the call taker will determine from the caller which emergency service they require (police, fire or EMS). In some cases more than one service is required and established protocols are used to determine the routing of the call. For example, in addition to police response, a motor vehicle accident (MVA) with injuries would be transferred to the ambulance service dispatch center and, in some cases, fire services may be alerted.

When a caller requires a service that acts as the Primary Service Answering Point (the RNC, RCMP, or St. John's Regional Fire Department), the call taker stays on the line with the caller, interrogates the caller as per the established protocols, and the dispatcher then dispatches the appropriate personnel. When the caller requires a different service than the answering PSAP, the caller is transferred to that 'downstream' agency. In some circumstances, such as in Corner Brook and Labrador City, the PSAPs are staffed by one person each shift. In addition to call taking and dispatching duties, that person provides support to the RNC members on duty and manages both telephone and walk-in inquiries from the public.

4.2. Outline of Technology Options

4.2.1 Basic 9-1-1

In a majority of cases, Basic 9-1-1 provides connection to an emergency call answer center via a protected network of dedicated trunk lines. But Basic 9-1-1 doesn't provide enhanced features that many people associate with 9-1-1, such as Automatic Number Identification and Selective Routing. Selective routing is the process by which 9-1-1 calls are sent to a specific PSAP based on the street address of the caller and is further described in Section 4.3. Instead of using Selective Routing, routing of a Basic 9-1-1 call to the appropriate 9-1-1 public safety answering center is determined by the location of the originating telephone central office only.

However, with the Basic 9-1-1 configuration that is currently in place in Newfoundland and Labrador (Corner Brook, Labrador City, and St. John's), Bell Aliant does not use dedicated trunk lines but has provided central office translations to route 9-1-1 dialed calls to a 7 digit number that terminates at the appropriate PSAP. There is no indication to a caller that the call they placed by dialing 9-1-1 is being redirected to a 7 or 10 digit number.

In order to cover those areas of the province that don't have wireline 9-1-1 service, this form of basic 9-1-1 could be extended by providing the central office translations to a toll free number(s) that terminates at the appropriate PSAP. In addition, where the functionality is available in the telephone company's central office switch, the calling line number and/or number associated with the voice call would be forwarded to the PSAP. However, the identification of the calling number would be available only as residential grade Calling Line Identification (CLID) but not as Enhanced 9-1-1 Automatic Number Identification (ANI), which means it is only revealed if the customer has agreed to do so. In cases where a telephone customer has elected not to have their telephone number displayed, or decides to block it by entering a blocking code before calling 9-1-1, a telephone number would not be displayed. Enhanced 9-1-1 will display a caller's telephone number even if he or she has tried to block it.

A translated number configuration is not as robust as a traditional Basic 9-1-1 implementation since there are no dedicated trunk lines and no redundant paths from the Central Offices to the PSAPs. This means that 9-1-1 is no more or less susceptible to service outages as the balance of the telephone infrastructure. Nevertheless, given that 9-1-1 translation is the method currently and historically used by Bell Aliant to access existing PSAPs in Newfoundland and Labrador, and that a long term goal would be to implement Enhanced or Next Generation 9-1-1 service which would include engineered 9-1-1 telephone circuits with appropriate cable and power supply redundancies, a translated 9-1-1 configuration is a reasonable and workable method for extending 9-1-1 to other areas of the province.

Originally Basic 9-1-1 service was intended for wireline customers only. In fact, the Bell Aliant 9-1-1 tariff states that "Wireless 9-1-1 calls are outside the scope of Basic 9-1-1 Service". However, mobile telephone companies serving Newfoundland and Labrador have provided, via their networks using call translation, access to Basic 9-1-1 service. Thus the 4 PSAPs in the province receive mobile 9-1-1 calls as well.

Figure 9 shows the Bell Aliant coverage map for cellular service. Bell provides the most extensive mobile network coverage in the province and subscribers should be able to reach 9-1-1 if they can get dial tone on their mobile devices. Other mobile companies' subscribers should be able to roam onto the Bell network for 9-1-1 service if their service provider does not have coverage.

Figure 9 - Provincial Cellular Coverage



4.3 Enhanced 9-1-1

This section describes the manner in which a call to 9-1-1 would be routed to a PSAP if an Enhanced 9-1-1 system is installed in the province. Several potential E9-1-1 configurations are also described.

Land Line Call: In an E9-1-1 system, calls dialed from a wired telephone would be recognized by Bell Aliant's local telephone switching system which would forward the call, together with the caller's Automatic Number Identification (ANI), to a Bell Aliant switch capable of hosting the Primary 9-1-1 Selective Router Tandem for Newfoundland and Labrador 9-1-1 system.

Selective routing is the process by which 9-1-1 calls are sent to a specific PSAP based on the street address of the caller. Of course, to work, civic addressing has to be in place. Street address ranges are associated with Emergency Service Zones (ESZ) which ascertain the responding emergency service agencies for an identified range of addresses. A call is routed automatically to an appropriate PSAP based on the ESZ.

Simultaneously, a central office switch would send the caller's telephone number (ANI) to Bell's Automatic Location Identification (ALI) computer, which decodes and queries its database to retrieve location information (ALI) related to the number that generated the call. ALI databases would be updated nightly from Bell Aliant's billing system.

When a voice call is delivered to a 9-1-1 PSAP, the data record from the ALI Computer System is sent to the PSAP's Computer Aided Dispatch (CAD) System and is displayed on the computer screen of the call taker receiving the call. This initial ALI information remains as a permanent record of the call even though edits may need to be made to the record by the call taker (for example, it is possible that the telephone number and address information of the caller is not the location of the emergency incident).

Cellular Call: In the case of a cell phone caller dialing 9-1-1, the call is picked up by a cellular tower and sent to the cellular company's Mobile Switching Center (MSC). The MSC recognizes the call as 9-1-1 and then forwards it to the Primary 9-1-1 switch (Selective Router). The Selective Router uses the number supplied by the Mobile Switching Center as a key, and checks a specialized Selective Routing Database (SRDB) for routing instructions. The 9-1-1 call is then forwarded to a predetermined PSAP for voice connection. The ALI computer, on initial answer, sends the caller's call back number, address of the cell tower site and the cellular company to the call taker's CAD display screen. Several seconds later the ALI computer will send a second data packet to the CAD system and the display screen will redisplay with the caller's Longitude, Latitude and Uncertainty factor in meters.

We considered two options for a traditional (also known as legacy) E9-1-1 implementation. These are:

E9-1-1 Configuration Option 1: Bell Aliant Local Selective Router:

- Selective Routers would be located in St. John's and Fredericton, New Brunswick. This option would require the installation of Selective Router 9-1-1 software on the Allandale central office switch and use of the existing City of Fredericton Selective Router central office.

E9-1-1 Configuration Option 2: Bell Aliant Remote Selective Router

- Existing selective routers in Fredericton and Moncton, New Brunswick would be used to provide E9-1-1 service.

4.3.1 E9-1-1 Configuration Option 1: Bell Aliant Local Selective Router

Option 1 would include new 9-1-1 software installed on the Bell Aliant switch at the Allandale central office which would be the Primary 9-1-1 Selective Router for Newfoundland. However, the selective router software was originally developed by Nortel and this part of the company's assets was purchased by a company named GENBAND which will not sell new E9-1-1

Selective Router software for the switch type in use at the Allandale Central Office. As well, even if new software could be accessed, GENBAND will not provide support after 2013. Additionally, Bell Aliant staff in Newfoundland and Labrador would have to be trained to maintain the software, which may not be a prudent use of resources considering that support will be ended by the vendor.

4.3.2 E9-1-1 Configuration Option 2: Bell Aliant Remote Selective Router

The second option would be to have the 9-1-1 service hosted by existing selective routers in another province. This option has some challenges including the cost of connectivity from Newfoundland and Labrador PSAPs to and from the host switching centers, which might be in Fredericton and Moncton, New Brunswick (please see Figure 10). The connectivity model would need to include a redundant path in case of failure of the primary link, and the cost of these connections often increase with distance. Also, there may be issues related to technological incompatibility that would need to be overcome by additional engineering, or the provision of interfacing technology with the PSAPs.

Figure 10 – Atlantic Provinces Legacy E9-1-1 Selective Router

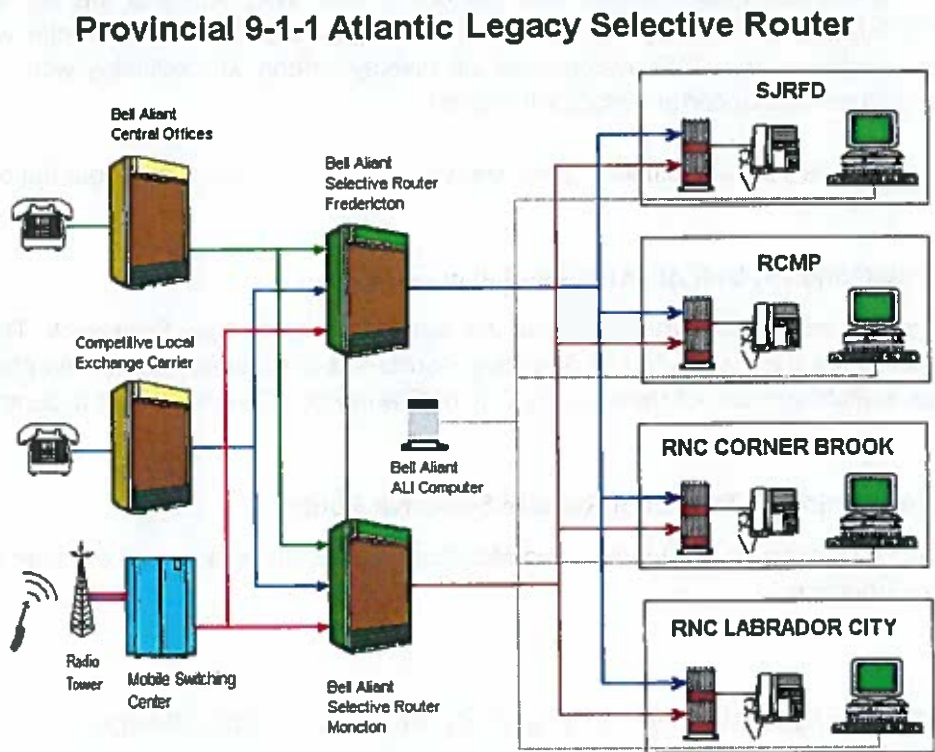

4.4. Next Generation 9-1-1

In order to be fully compliant with NENA Next Generation 9-1-1 definitions, a baseline NG9-1-1 system must include the functions of a current E9-1-1 system, replicated in internet protocol (IP) and structures, including all network and PSAP components of the system. Some capabilities, beyond traditional E9-1-1 functions, should also be included such as the basic ability to support non-voice multimedia (text and video) (please see **Next Generation 9-1-1 (NG9-1-1)** in the glossary).

Support for legacy originating services via gateways (e.g., access to traditional ALI databases), is required in addition to Geospatial controlled IP software call routing functions, defined by NENA as Emergency Call Routing Function (ECRF). The capital costs outlined in the next section allow for the maintenance of traditional ALI Databases as well as Next Gen [Location Information Server](#) (LIS).

There are two Next Generation 9-1-1 options that are distinguished more by their governance. These are:

NG9-1-1 Configuration Option 1: Bell Aliant NG9-1-1 Selective Router

- IP Selective Routers located in the cities of St. John's and Corner Brook and hosted by Bell Aliant. This option would install two new NG9-1-1 Selective Routers to be located at the Allandale central office and Corner Brook central office.

NG9-1-1 Configuration Option 2: Third Party NG9-1-1 Selective Router

- Two new NG9-1-1 Selective Routers located at two geographically diverse locations and hosted by a Third Party rather than Bell Aliant.

4.4.1 NG9-1-1 Configuration Option 1: Bell Aliant Local NG9-1-1 Selective Router

The first option would be to have the 9-1-1 service hosted by two new NG9-1-1 Selective Routers in the Bell Aliant central offices located in St. John's and Corner Brook (Figure 11).

Figure 11 - Next Generation 9-1-1 Hosted by Bell Aliant

Provincial 9-1-1 Bell Aliant NG9-1-1

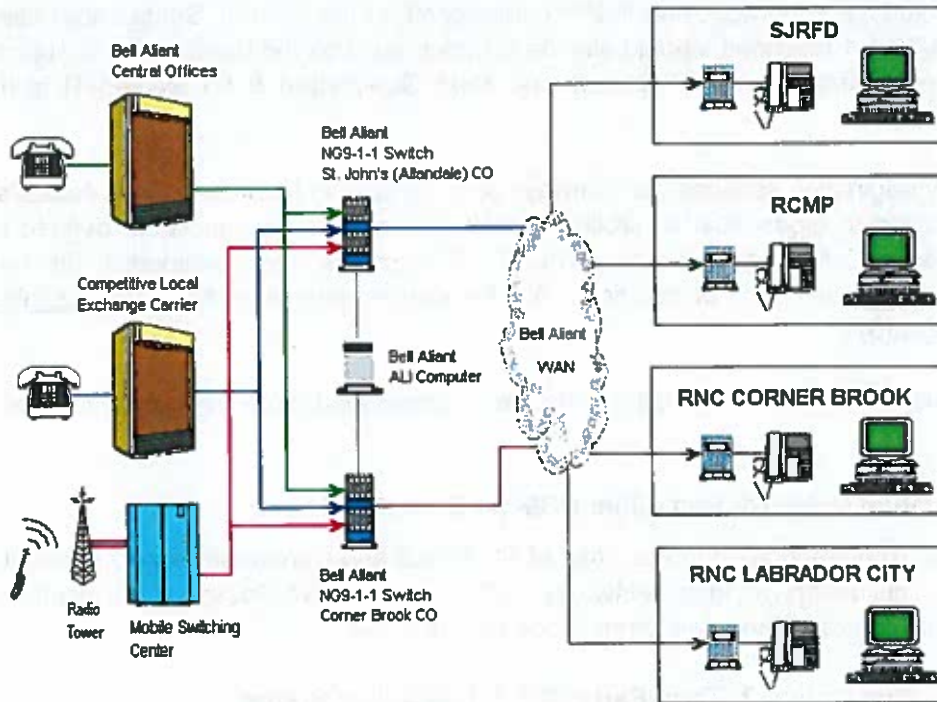

In the diagram above 'Bell Aliant WAN' represents a wide area network

4.4.2 NG9-1-1 Configuration Option 2: Third Party NG9-1-1 Selective Router

The second option would be to have the 9-1-1 service hosted by two new NG9-1-1 Selective Routers but operated by a third party (non-telephone company organization). The routers could be housed in the third party operator's facilities in St. John's and Corner Brook, in government buildings, or another acceptable location.

This option will require Agreements with Bell Aliant, other telephone service providers and wireless service providers for trunk connections from their switches to the NG9-1-1 switches for the delivery of the 9-1-1 caller to the PSAPs (Figure 12).

Figure 12 - Next Generation 9-1-1 Third Party Hosted

Provincial 9-1-1 Third Party NG9-1-1

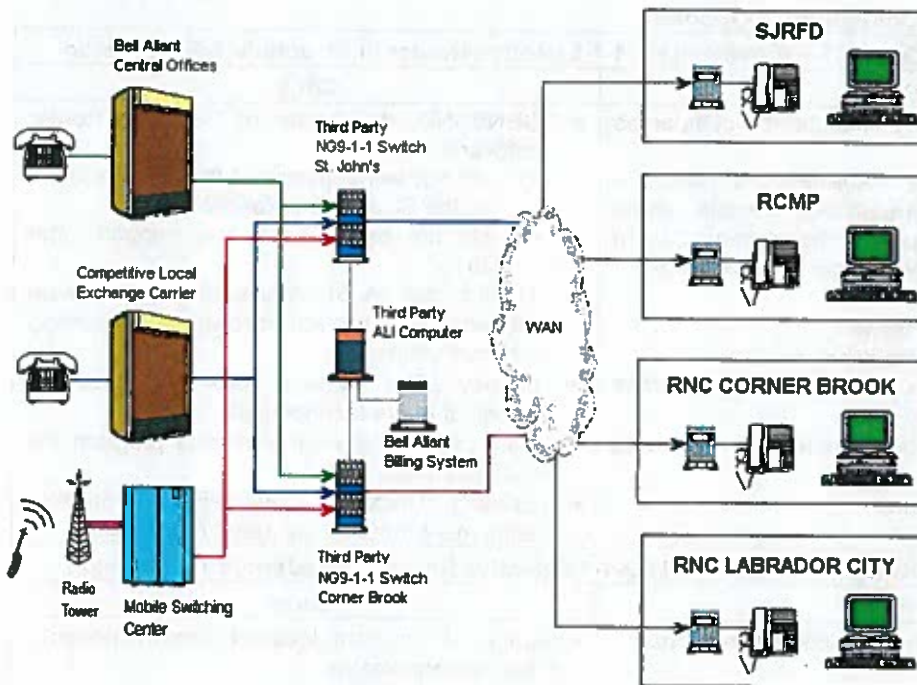

In the diagram above 'WAN' represents a wide area network

4.5 Summary and Comparison of Options

The options considered are summarized in Table 1 below:

Table 1- Summary of Configuration Options

Traditional E9-1-1 Option 1 – Provincial E9-1-1 Selective Router in St. John's & Fredericton	
Pros	Cons
<ul style="list-style-type: none"> • Standard used by telephone companies across Canada • Would require the installation of Selective Router 9-1-1 software on the Allandale central office switch and use of the existing City of Fredericton Selective Router central office • Bell Aliant would: <ul style="list-style-type: none"> ▪ tariff the 9-1-1 service ▪ install and maintain the service ▪ look after the Master Street Address Guide (MSAG) • Fredericton Selective Router is in service today • Existing ALI Computer 	<ul style="list-style-type: none"> • GENBAND, the owner of Selective Router software: <ul style="list-style-type: none"> ▪ will not sell software of the type required for the St. John's (Allandale) switch ▪ will not provide software support after 2013 • Aliant's staff in St. John's may have to be trained to maintain software which is reaching a sunset phase • Legacy 9-1-1 system does not meet the needs of future technologies • Cost to install the software and program the routing tables • Existing Customer (the PSAPs) premise equipment for 9-1-1 will require updating
Traditional E9-1-1 Option 2 – Provincial E9-1-1 Selective Router in Fredericton & Moncton	
Pros	Cons
<ul style="list-style-type: none"> • Standard used by telephone companies across Canada • Bell Aliant would tariff the 9-1-1 service • Bell Aliant would install and maintain the service • Existing E9-1-1 switches in Fredericton and Moncton would be used to serve the province's 4 PSAPs • Bell Aliant would look after the Master Street Address Guide (MSAG) • Fredericton and Moncton Selective Routers are in service today • Existing Wireless Service Providers interface to SR's • Existing ALI Computer 	<ul style="list-style-type: none"> • Legacy 9-1-1 system does not meet the needs of future technologies • Cost to program the routing tables • Both Selective Routers are in another province requiring the use of additional telecom facility links • Additional services may need to be engineered to support the distance and redundant services between provinces • Existing Customer Premise Equipment for 9-1-1 will require updating

Table 1 - Summary of Configuration Options Cont.

Next Generation 9-1-1 Option 1 – Provincial 9-1-1 Bell Aliant NG9-1-1 Switch (St. John's & Corner Brook)	
Pros	Cons
<ul style="list-style-type: none"> • Full E9-1-1 features which will support future technologies • Bell Aliant would tariff the 9-1-1 service • Bell Aliant would install and maintain the service • NG9-1-1 switches located in central offices • Bell Aliant would look after the MSAG/LIS • NG9-1-1 switches located in Newfoundland • Robust back-up of PSAPs 	<ul style="list-style-type: none"> • New technology with new processes required • Need to ensure that the robustness of telephone company facilities in Labrador West will support an NG option • Existing Customer Premise Equipment (the PSAPs) for 9-1-1 will require updating
Next Generation 9-1-1 Option 2 – Provincial 9-1-1 Third Party NG9-1-1 Switch (St. John's & Corner Brook)	
Pros	Cons
<ul style="list-style-type: none"> • Full E9-1-1 features which will support future technologies • Technology costs covered through Cost Recovery fee not the 9-1-1 Service Fee • MSAG/LIS would be available to other government departments • NG9-1-1 switches located in Newfoundland • Robust back-up of PSAP's • Best cost and service could be secured through an RFP or tendering process 	<ul style="list-style-type: none"> • New technology with new processes required • Need to ensure that the robustness of telephone company facilities in Labrador West will support an NG option • The system will have to be maintained by the province or a contracted third party • New ALI/LIS Computer will be required • Existing Customer Premise Equipment for 9-1-1 will require updating

5. Summary of Costs

This section outlines capital and operating costs for the options discussed in Section 4.

We have obtained quotes for the initial capital costs and for third party hosting of an ANI/ALI database from vendors that POMAX has worked with previously. While the summaries are included herein, the detailed quotes are not; this is due to the competitive confidentiality required by the vendors.

5.1 Computer Telephony Integration

Because of the challenges of transferring 9-1-1 calls to a very high number of agencies, particularly fire services with potentially up to 300 different answer points, we recommend, for all configurations that are described below, in a province-wide 9-1-1 system, the use of a computerized telephony interface or system (CTI). Essentially this makes the notification of a downstream agency a simple selection on the computer screen, compared to having to look up the name of the community and response agency, the telephone number associated with that agency, and then dialing it manually or selecting a speed dial sequence.

Thus workstations at each PSAP would be upgraded to IP based Intelligent Workstations (IWS) that provide call takers with on-screen management of both landline and wireless calls in a wide variety of telephony environments. Intelligent Workstations:

- include Integrated TTY (teletypewriter), and can implement Text to 9-1-1 for the Deaf and Hearing Impaired Community;
- have Integrated Call Check recording (instant recall of recent telephone conversations and calls for assistance);
- have one-click contact buttons that automatically perform the correct transfer type or speed dial;
- allow the most commonly dialed agencies to be shown separately as hot keys;
- support automatic failover to a secondary phone switch either on premise or at the backup center.

A representative view of a Computerized Telephony Screen is shown in Figure 13.

Figure 13 - Computerized Telephony Screen

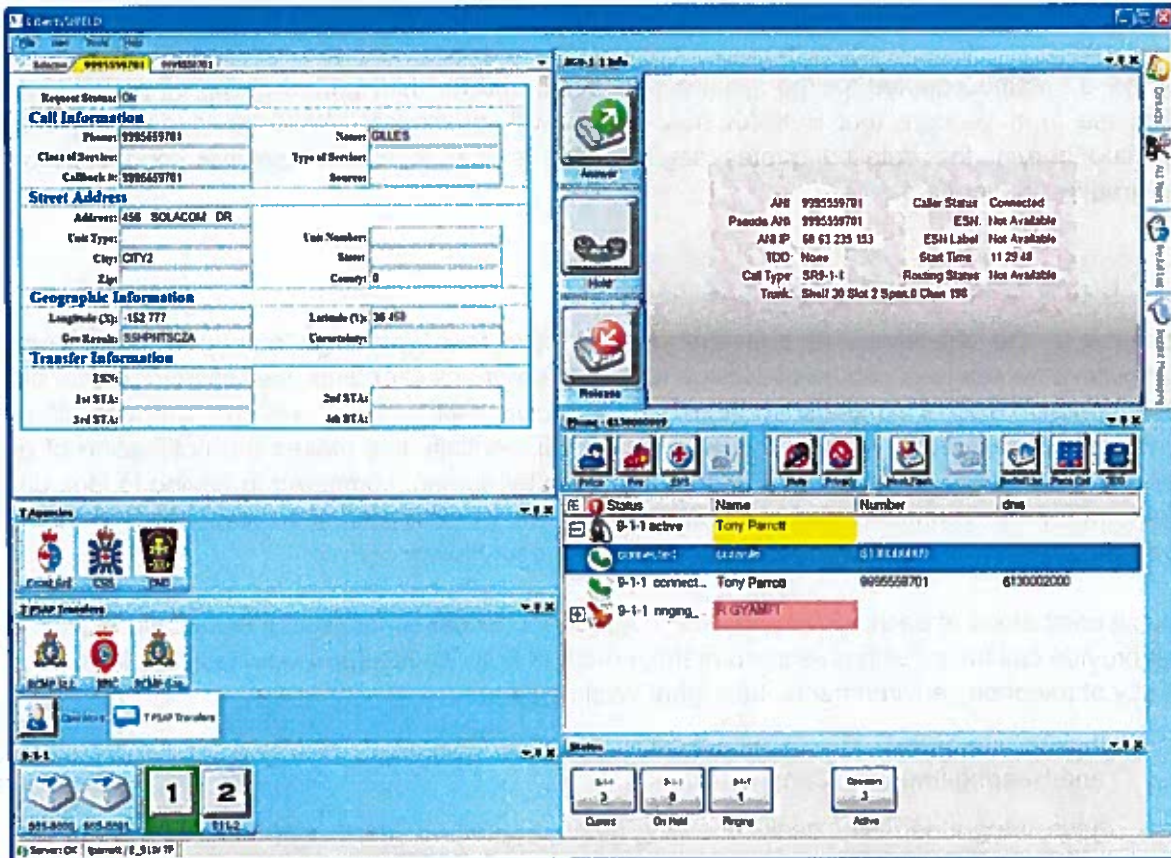

We have shown the cost of a Computerized Telephony Interface as an option in this summary.

5.2 Wireline and Wireless Phone Estimates

In order to calculate costs and potential revenue from a Service Fee and Cost Recovery Fee (please see Sections 5.3 and 5.4) it is necessary to estimate the number of wireline and wireless phones in the province. Since telephone and wireless companies will not provide this information because it is considered competitive and proprietary we turned to Industry Canada, Statistics Canada, and the Canadian Wireless Telecommunications Authority (CWTA) to develop an estimate. In some cases statistics specific to Newfoundland and Labrador were not available so we have had to use country-wide statistics to estimate provincial per capita results.

- According to Industry Canada there were 26,333 businesses in N&L in 2010⁶;
- StatCan indicates there was a population of 510,600 and 235,958 households in Newfoundland and Labrador in 2011⁷;
- StatCan also indicates that more households are abandoning their traditional landline telephones in favor of wireless phones only. In 2010, 13% of households across Canada reported they used a cell phone exclusively, up from 8% in 2008⁸;
- The CWTA indicates that there were 25,543,862 wireless subscriptions in Canada in calendar Q3 of 2011⁹.

Some of those 26,333 businesses, indicated by Industry Canada, will be micro or mobile businesses where a wireless phone would be used as a business phone, or a home phone and business phone would be one and the same. Also, many businesses will have multiple lines. Using StatCan's figures that 13% of households reported they used a cell phone exclusively (therefore 87% of the population had residential wireline telephones), we estimated that there are 205,000 residential wireline phones in Newfoundland and Labrador (235,958 households x 87% = 205,000). To that we added 26,000 business phones for a total of 231,000 wire line phones.

We admit that the assumptions on which these estimates are based leave a lot to be desired but we have not been able to find more precise numbers specific to the province.

The CWTA reports there were 25,543,862 wireless subscribers in Canada in Q3 of 2011. Statistics Canada identifies the population of Canada in 2011 as 34,482,800⁷ which translates to the equivalent of 1 wireless phone per 1.35 people or, stated another way, 74% of the population has a wireless phone. In researching this report we talked to CWTA representatives to determine if it has a breakdown of wireless telephones specific to Newfoundland and Labrador, but it doesn't. So, for lack of a better methodology, we estimated the number of mobile phones for Newfoundland and Labrador by taking the Statistics Canada provincial

⁶ <http://www.ic.gc.ca/eic/site/sbrp-rppe.nsf/eng/rd02493.html>

⁷ <http://www40.statcan.ca/01/cst01/demo02a-eng.htm>

⁸ StatCan; The Daily, Tuesday April 5, 2011; Residential Telephone Service Survey

⁹ http://cwta.ca/wordpress/wp-content/uploads/2011/11/SubscribersStats_en_2011_Q3.pdf

population figure of 510,600 people and multiplying it by .74 to arrive at a figure of 377,844 wireless phones.

Table 2 - Estimated Number of Wireline And Wireless Phones

Type	Number of devices/lines
Wireline phones	231,000
Wireless devices	377,844
Total	608,844

5.3 Bell Aliant's Service Fee

A Service Fee is a tariff, approved by the CRTC, that is collected by telephone companies, for each wireline and wireless phone, to cover the costs of developing and maintaining a 9-1-1 network including trunk lines, selective routing software and hardware, ANI/ALI database development and maintenance, and the termination of 9-1-1 calls at the demarcation point of a PSAP and secondary call answer centers.

Bell Aliant has provided an estimate of the Service Fee, based on their tariff charges in other provinces, of \$0.25 to \$0.35 per phone per month. In order to project cost defrayment potential from the service fee we have taken the top end of the estimate of \$0.35 per wireline phone. The existing tariff for wireless phones is 50% of the wireline tariff which would therefore be \$0.175 per month.

Bell Aliant has indicated that they charge an additional \$0.0054 per wireless phone to handle Phase I (calling number identification and cell tower location) and an additional \$0.0028 per wireless device for Phase II (location information) technology. Table 3 shows the calculation leading to the projected annual revenue from the service fee, based on the calculation of the number of phones in Table 2.

Table 3 – Projected Annual Service Fee Revenue

Fee	Amount	Number of lines/phones	Monthly Revenue	Annual Revenue
Wireline Service Fee	\$0.35000	231,000	\$80,850.00	\$970,200.00
Base Wireless Service Fee	\$0.17500			
Phase I incremental Service Fee	\$0.00540			
Phase II incremental Service Fee	\$0.00280			
Total Wireless Service Fee	\$0.18320	377,844	\$69,221.02	\$830,652.25
Total Annual Revenue				\$1,800,852

If a legacy Enhanced 9-1-1 configuration is employed (please see Sections 4.3.1 and 4.3.2), this fee would be collected and retained by Bell Aliant, which would be responsible for the 9-1-1 network to the demarcation point in the 9-1-1 PSAP, and from the 9-1-1 PSAP to the secondary answer centers. In this model the PSAPs are not involved in the provision or maintenance of the network.

Within the Next Generation 9-1-1 third party hosted configuration (please see Section 4.4.2), we have made the assumption that, similar to the trend in the United States, the provision and maintenance of Emergency Services Internet Protocol network components (the [ESInet](#)) will be supplied directly by third party vendors rather than telephone companies. A third party hosted configuration also has the advantage of allowing government to tender for the service and secure the best service and equipment for the price paid. With a telephone company hosted solution provincial and municipal governments - and consumers who pay for the service through their phone bill - have to depend upon CRTC tariff filings to ensure that telephone company fees are reasonable.

In a third party hosted model the Service Fee collected by Bell Aliant would cover the connectivity costs to the ESInet and general network costs only, meaning that the original \$0.35 per month subscriber estimate would be significantly reduced however, cost recovery fees would likely increase (please see Section 5.4).

5.4 Cost Recovery Fee

A Cost Recovery Fee is collected by phone companies on a set rate per wireline, and sometimes wireless, phone on behalf of the governing jurisdiction for 9-1-1. The fee is remitted to the jurisdiction, by the telephone company, and is used to offset the jurisdiction's costs in connection with the provision of 9-1-1 Services. It is also traditionally used to cover all costs and expenses incurred by a jurisdiction to provide 9-1-1 capability and functionality including, but not limited to:

- equipment purchases, installation and maintenance;
 - Computer Telephony Interface equipment – for handling the call taking and downstream transfer process (if this option is selected);
 - development of the Master Street Address Guide (MSAG) database;
- software acquisition and maintenance;
 - Interfaces to the Computer Aided Dispatch Systems;
- 9-1-1 call answer center staffing;
- other personnel enhancements if required; and,
- costs of public awareness campaigns.

In some circumstances, telephone companies are allowed an administration charge to collect and remit the cost recovery fee. For example, in British Columbia it is 7 cents per telephone line.

In the case of a Next Generation 9-1-1 configuration the cost recovery or service fees would also cover capital and ongoing costs for the Emergency Services Internet Protocol network components. It is also likely, in an NG9-1-1 configuration that voice logging systems and instant recall recorders would have to be upgraded. Those costs are not known at this time but are not expected to be significant, likely less than \$5,000 per existing PSAP.

The approximate capital cost to establish Basic 9-1-1, Enhanced 9-1-1, or NG9-1-1 in Newfoundland and Labrador is shown in Table 4; however, the costs for the optional Computer Telephony Interface (CTI) (please see Section 5.1) are not included. Those costs are demonstrated in Table 5. It should be noted that CTI is included as part of the cost of a Next Generation solution. So the decision as to whether to choose a CTI would only be made in the case of implementing a Basic 9-1-1 or Legacy E9-1-1 option.

Ongoing costs, within the legacy E9-1-1 option and Option 1 of NG9-1-1, are expected to be covered by a Bell Aliant 9-1-1 Service Tariff. Capital costs for the PSAP components would be collected via the Cost Recovery Fee and remitted to the governing body for 9-1-1 in the province. In Option 2 of the NG 9-1-1 system, capital costs for the PSAP components would be paid for from provincial revenues or via a cost recovery fee.

Table 4 - Initial Capital Costs without Computer Telephony Interface

	Basic 9-1-1 Option	Legacy E9-1-1 Option	Next Generation 9-1-1	
			Option 1 Bell Aliant Hosted	Option 2 Third Party Hosted
PSAP capital equipment		\$153,000	\$1,150,774	\$1,150,774
Contingency (20%)		\$30,600	\$230,155	\$230,155
TOTAL		\$183,600	\$1,380,929	\$1,380,929

Table 5- Initial Capital Costs with Computer Telephony Interface

	Basic 9-1-1 Option	Legacy E9-1-1 Option	Next Generation 9-1-1	
			Option 1 Bell Aliant Hosted	Option 2 Third Party Hosted
PSAP capital equipment	\$505,786	\$605,786	\$1,150,774	\$1,150,774
Contingency (20%)	\$101,157	\$121,157	\$230,155	\$230,155
TOTAL	\$606,943	\$726,943	\$1,380,929	\$1,380,929

5.5 Annual Operating Costs

5.5.1 Basic 9-1-1

To calculate the ongoing costs for Basic 9-1-1 using number translation (please see Section 1), we have estimated the percentage of the population that does not have access to wireline 9-1-1 service by subtracting the population that does have 9-1-1 wireline service from the total provincial population as shown in Table 6.

Table 6 - Population Not Covered by Basic Wireline 9-1-1

Area	Population
Provincial Population ¹⁰	510,600
Population Currently Covered by 9-1-1 Service	
<i>Northeast Avalon</i>	192,326 ¹⁰
<i>Corner Brook/Humber Valley/Bay of Islands</i>	32,153 ¹¹
<i>Labrador City/Wabush</i>	8,980 ¹²
<i>Sub-Total</i>	233,459
Population Not Covered by Basic Wireline 9-1-1	277,141

Therefore, approximately 277,140 people in the province do not have access to wireline 9-1-1 service but we are unsure how this population breaks down from the perspective of number of households. Of course 9-1-1 is available province-wide from a mobile phone assuming wireless coverage is available.

We next need to estimate the 9-1-1 call volume per capita based on statics from the existing centers (Table 7).

Table 7 - Per Capita Call Volume

Area	Population	Annual Call Volume	Per Capita Volume
Northeast Avalon	192,326 ¹³	30,629 ¹⁴	0.16
Corner Brook; Humber Valley; Bay of Islands	32,153 ¹⁵	2,101 ¹⁶	.07
Labrador City; Wabush	8,980 ¹⁷	204 ¹⁶	.02

We know, from Section 2, that New Brunswick, with a population of 753,200 experiences 168,000 9-1-1 calls per year (.22 per capita), and Prince Edward Island, with a population of 143,500 experiences 27,840 9-1-1 calls per year (.19 per capita). Therefore, although it will take

¹⁰ http://www.stats.gov.nl.ca/Statistics/Population/PDF/Population_Estimates_CDCMA.pdf

¹¹ <http://www.aq.gov.nl.ca/aq/annualReports/2005AnnualReport/CH2.19.pdf>

¹² <http://www.labradorwest.com/default.php?display=cid157>

¹³ http://www.stats.gov.nl.ca/Statistics/Population/PDF/Population_Estimates_CDCMA.pdf

¹⁴ Sherry Colford, Manager, Communications (9-1-1) and Program Development. St. John's Regional Fire Department

¹⁵ <http://www.aq.gov.nl.ca/aq/annualReports/2005AnnualReport/CH2.19.pdf>

¹⁶ Sergeant Rich Wheeler, NCO i/c Support Services, Royal Newfoundland Constabulary

¹⁷ <http://www.labradorwest.com/default.php?display=cid157>

several years to occur, it is reasonable to expect that Newfoundland and Labrador will eventually end up with a 9-1-1 call per capita of approximately .16 to .19 which is the ratio currently occurring in the Northeast Avalon.

If we use a ratio of .16 calls per capita, since it seems more representative of expected per capita call volume in the province, then we can predict that the total call volume for the unserved population of 277,141 would be 44,343 annually ($277,141 \times 0.16 = 44,343$). At an average length of 3 minutes per call and a toll rate of \$0.17 per minute (based on our rates for toll free service - government rates may be less), each call would be approximately \$0.51 for an annual cost of \$22,615.

As can be seen, the cost of extending Basic 9-1-1 to the balance of the province that currently does not have access to that service can be achieved for approximately \$22,615 a year. Annual costs will increase by approximately \$64,400 per year if the Computer Telephony Interface option, shown in Table 9 is chosen. Bell Aliant may levy some one time service charges for implementing Translation-encoded instruction but we are not sure what they might be until additional 9-1-1 geographic areas are defined.

Some other costs may be incurred if a decision is made to implement a province-wide Basic 9-1-1 system. For example, a minimal cost for maps and mapping maintenance may be required and, eventually, PSAP staff levels may need to be increased to accommodate the estimated 44,343 additional calls. However, if one considers that the call routing portion¹⁸ of most 9-1-1 calls takes less than 20 seconds, the actual impact of handling the additional 44,343 calls is 246 staff hours a year¹⁹. On average, that would amount to 1½ additional weeks of work per year for the existing PSAPs. However, it is possible that province-wide implementation of Basic 9-1-1 could result in a slight increase in staffing during the mid to later stages of implementation.

5.5.2 Enhanced and Next Generation 9-1-1

All capital, maintenance, and licensing cost estimates in this section are approximate and preliminary and have been provided by vendors that POMAX has worked with in the past. While the summaries are included below, the details which roll up to the estimates exhibited are not due to the competitive confidentiality required by the vendors.

Table 8 and Table 9 provide the annual maintenance and ongoing license costs for Next Generation and E9-1-1 configurations, in addition to Basic 9-1-1.

¹⁸ In a Basic 9-1-1 configuration, the call routing portion at a PSAP is when the call taker answers the telephone, asks the caller if they want police, fire, or EMS help, and then transfers (routes) the call to the appropriate responding agency. Other work, which includes taking detailed information about the incident, dispatching resources, and perhaps remaining on the line until responders arrive at the scene, are the duties of the responding agency's dispatch center, not the PSAP's.

¹⁹ $44,343 \times 20 \text{ seconds} = 886,860 \text{ seconds} = 246 \text{ hours}$

Table 8 - Annual Maintenance & License Costs & Recurring Charges without Computer Telephony Interface

	Basic 9-1-1 Option	Legacy E9-1-1 Option	Next Generation 9-1-1	
			Option 1 Bell Aliant Hosted	Option 2 Third Party Hosted
Toll Free Charges	\$22,615	\$0	\$0	\$0
Annual Maintenance			\$82,938	\$82,938
ALI/LIS Database License		\$100,000	\$195,463	\$195,463
Contingency (20%)			\$16,588	\$16,588
TOTAL	\$22,615	\$100,000	\$294,989	\$294,989

Table 9 - Annual Maintenance & License Costs & Recurring Charges with Computer Telephony Interface

	Basic 9-1-1 Option	Legacy E9-1-1 Option	Next Generation 9-1-1	
			Option 1 Bell Aliant Hosted	Option 2 Third Party Hosted
Toll Free Charges	\$22,615			
Annual Maintenance	\$64,417	\$64,417	\$82,938	\$82,938
ALI/LIS Database License		\$100,000	\$195,463	\$195,463
Contingency (20%)	\$12,883	\$12,883	\$16,588	\$16,588
TOTAL	\$99,915	\$177,300	\$294,989	\$294,989

The ALI/LIS Database license cost of \$100,000 attributed to the Legacy E9-1-1 option, in Table 9, is purely an estimated number based on effort required by the phone company to support the addition of records for Newfoundland and Labrador to their existing ALI database.

The tables above show a significant difference in the initial capital and ongoing costs for a legacy E9-1-1 system versus a Next Generation 9-1-1 solution. The main consideration in moving towards a Next Generation platform is the length of time legacy systems will be maintained in Canada before the emergency services industry, the CRTC, and perhaps even the telephone companies push for a migration to new technology. This conversion is already underway in the United States, and it is possible that a decision by Newfoundland and Labrador to invest in a legacy system will result, in a few years, by a further need to invest in the migration to a NG9-1-1 solution. Conversely, Canada may move slower and it is conceivable that the current infrastructure in Canada would remain in place for many years.

To complete this phase of the study POMAX met with Bell Aliant to work through a number of issues regarding the practicalities of implementing a legacy E9-1-1 system versus a Next Generation 9-1-1 system. Some of the questions explored with Bell Aliant follow below.

Although this report does not present answers on a question by question basis, the results of our discussions and research are reflected throughout.

- 1) Within a legacy E9-1-1 solution hosted by Bell Aliant using existing Selective Routers in New Brunswick:
 - a) How long does Bell Aliant expect to maintain a legacy solution before moving to NG9-1-1 for the other provinces considering that GENBAND has sunsetted the software used in the legacy E9-1-1 system?
 - b) What is the recommended interface for 9-1-1 trunks?
 - c) Can a CTI solution be implemented with a legacy E9-1-1 system?
 - d) If so what would that interface be?
 - e) What solution would Bell Aliant recommend for areas without existing civic addresses?
- 2) Within a Bell Aliant Hosted NG9-1-1 Option:
 - a) Would Bell Aliant consider NG9-1-1 to be the most viable option in 3 -5 years?
 - b) Would they consider tariffing NG9-1-1 as part of the Service Fee?
 - c) Would they include a CTI solution in the tariff?
 - d) Would the total solution be supported by Bell Aliant or would they turn to another company to manage, for example, the IP network?
 - e) What solution would Bell Aliant recommend for areas without existing civic addresses?
- 3) Within a Third Party Hosted NG9-1-1 Option:
 - a) Would Bell Aliant offer the network to connect the switches to the ESInet?
 - b) How would Bell Aliant connect wireline service to the NG9-1-1 Selective Routers?
 - c) Would Bell Aliant consider collecting the 9-1-1 Cost Recovery Fee for the Province?

5.6 Staffing and Other Costs in a Province-wide Next Generation 9-1-1 System

We have had to make some assumptions in order to come up with a cost estimate for the full implementation of a Next Generation 9-1-1 throughout the province. Readers should note that these estimates could vary significantly from a final tally, however, further investigation after this feasibility study and the involvement of various government departments and stakeholders will refine the approximations discussed in this section.

The capital cost estimate for the implementation of a 9-1-1 system in Newfoundland and Labrador is based on a Next Generation configuration, since that represents the greatest initial cost. So, capital costs for 9-1-1 server equipment is estimated at \$1.38 million (Table 5, page 25).

Annual maintenance estimates are also based on a Next Generation configuration. Therefore, annual maintenance of a province wide NG9-1-1 system is estimated at approximately \$295,000 (Table 9, page 28).

Salaries, wages, and benefit (SW&B) costs, shown in Figure 14, are based on costs from projects we have conducted in other jurisdictions but may be overestimated compared to actual SW&B in Newfoundland & Labrador.

Figure 14 - NL 9-1-1 Related Salaries, Wages, & Benefits

PSAP Staff Increases (based on 2085 hours per year/FTE)						
	Staff Increase FTE	Absence Replacement Hours	Estimated Hourly Rate	SW&B + Absence Replacement	Benefits @ 28% of Regular Wages	Total Annual Cost
St. John's Regional Fire Department	2085.60	702	\$34.50	\$96,179.17	\$28,930.17	\$123,109.34
RCMP B Division	5840	2169	\$34.50	\$276,300.29	\$77,364.08	\$353,664.37
RNC Corner Brook	2086	775	\$34.50	\$98,678.67	\$27,630.03	\$126,308.70
RNC Labrador City	0	0	\$34.50	\$0.00	\$0.00	\$0.00
9-1-1 Bureau staff						
	Complement		Annual S&W	Result	Benefits @ 28% of Regular Wages	Total Annual Cost
Bureau Director	1		\$125,000	\$125,000	\$35,000.00	\$160,000.00
IT / Telephony Staff	2		\$68,988	\$137,976	\$38,633.28	\$176,609.28
Civic Addressing - Mapping	1		\$68,988	\$68,988	\$19,316.64	\$88,304.64
Administrative Support	1		\$44,417	\$44,417	\$12,436.76	\$56,853.76
GIS and IT Support Other Provincial Departments						
	Complement		Annual S&W		Benefits @ 28% of Regular Wages	Total Annual Cost
GIS Staff	2		\$68,988	\$137,976	\$38,633.28	\$176,609.28
IT Staff	1		\$68,988	\$68,988	\$19,316.64	\$88,304.64
Total Annual Staff Commitment						\$1,349,764

Hardware, recurring charges (map, software, and data purchases), and other capital costs to support a province-wide E9-1-1 system are estimated at \$217,560 (Figure 15).

Figure 15 - Hardware Capital Costs

Hardware Capital Costs		
GIS Servers	\$27,356	Basic hardware support included
Storage	\$40,000	
Software	Assumed that the province has GIS software	
Mapping purchases (satellite & conventional)	\$100,000	
Sub-Total	\$167,356	
Contingency 30%	\$50,207	
Total	\$217,563	

A facility of approximately 110 square meters to house the 9-1-1 Bureau, assuming space was not available in government facilities, could require a capital investment of \$220,000 (land costs not included) with operating costs of approximately \$6,600 a year (calculated at 3% of capital costs). Alternatively, leasing acceptable space would require about \$24,000 a year.

So, we calculate that to set up a 9-1-1 Bureau, ensure adequate support from other government departments, purchase and maintain hardware and software, and enhance staff levels at the 4 PSAPs to accept increased call volume, will require a capital investment of approximately \$1.5 million (Figure 16) and annual costs of \$1.8 million a year upon full implementation (Figure 17). This staffing and bureau configuration may take several years to put into full effect depending upon the speed of Basic 9-1-1 roll out and eventual Next Generation 9-1-1 implementation.

Figure 16 - Capital Equipment

PSAP capital equipment	\$1,150,774	From Table 5
Contingency (20%)	\$230,155	From Table 5
GIS Servers	\$27,356	From Figure 15
Storage	\$40,000	From Figure 15
Contingency 30%	\$50,207	
Total Capital Investment	\$1,498,492	

In addition to the Total Capital Investment of \$1,498,492, an accrual of \$500,000 needs to occur annually to replace the capital equipment on a 3 year evergreen cycle. ($\$1,498,492 / 3 = \$499,497$).

Figure 17 - Recurring costs

Mapping purchases (satellite & conventional)	\$100,000	From Figure 15
Toll Free Charges	\$22,615	From Table 8
Annual Maintenance	\$82,938	From Tables 8 & 9
AL/LIS Database License	\$195,463	From Tables 8 & 9
Contingency (20%)	\$16,588	
Facility Lease	\$24,000	
Annual Staff Costs	\$1,349,764	From Figure 14
Total Recurring Costs	\$1,791,368	

Therefore, full implementation of a province-wide Next Generation 9-1-1 system is estimated to require a capital investment of \$1,498,492 (1.5 million), and recurring costs of \$2,290,865 (\$1,791,368 from Figure 17 plus \$499,497 annual evergreen accrual).

5.6.1 Cost Recovery

Considering that there are estimated to be 231,000 land line telephones and 377,844 wireless phones in Newfoundland and Labrador for a total of 608,844 telephones:

- and if a decision was made to recover costs – either by the telephone company or the province – based upon a monthly fee per telephone line or subscription;
- and if a 3 year evergreen cycle was instituted for the PSAP capital equipment (Figure 16)
- then \$2.3 million per year would have to be recovered to fund a provincial NG9-1-1 system.

That translates to \$0.31 per telephone line or subscription per month. In addition, depending on the Enhanced or Next Generation 9-1-1 option that may be chosen, Bell Aliant may approach the Canadian Radio-television Telecommunications Commission to revise their tariff to allow for a service fee related to establishing and maintaining a 9-1-1 network. In other provinces that tariff has been approved at between 25 cents to 35 cents per month per telephone line. It is possible, therefore, that a combined cost recovery and service fee could amount to approximately 66 cents per month.

6 Civic Addressing to Support an E9-1-1 or NG9-1-1 System (Location Based Data)

6.1 Intent

The intent of this section is to provide information as to whether data exists to enable the province to establish, alone or with partners, civic addressing throughout the province to support an Enhanced or Next Generation 9-1-1 system. We found existing geographic data to be more than adequate for this purpose.

6.2 Location Fundamentals

In mapping terms, a geographic location represents a specific place on earth located within a coordinate system. A geographic location can be digitally obtained using Location Based Data (LBD) to capture, map, and provide a geographic context to a certain location (i.e. where it is, what it is, and what is around it). In the case of 9-1-1 systems, sources of Location Based Data can include Global Position Systems (GPS), digital orthophotography²⁰, satellite imagery, or existing topographic mapping. The Location Based Data will have a resolution or scale that is representative of the level of definition or detail of the geographic feature; the higher the resolution or larger the scale, the more detailed the definition of the feature. Features within geographic data layers used in 9-1-1 displays can be either an area represented by a polygon, a linear feature defined by a polyline, or a point location. A polygon is a map feature bounding an area at a given scale, such as a municipal boundary or a land parcel in a city map. A polyline is a map feature representing a place or thing that has a length but not an area at a given scale, such as a utility transmission line. Last, a point feature has neither a length nor an area at a given scale, an example being a water hydrant. In a digital format, these three geometries are represented by a single vertex (i.e. point) or multiple vertices joined into segments (i.e. polyline or polygon).

Associated with these geographic features is a coordinate system that is used to define the location of a particular feature with respect to its position and an elevation. For traditional 9-1-1 applications, locating a feature is done using a horizontal coordinate system of longitudes and latitudes expressed as degrees of a sphere (i.e. the Earth) as shown in Figure 18.

²⁰ An orthophoto, is an aerial photograph geometrically corrected ("orthorectified") so that the scale is uniform and the photo has the same lack of distortion as a map. An orthophotograph can be used to measure true distances because it is an accurate representation of the Earth's surface, and has been adjusted for topographic relief, lens distortion, and camera tilt.

Figure 18 - Degrees of latitude (north-south) and longitude (east-west)

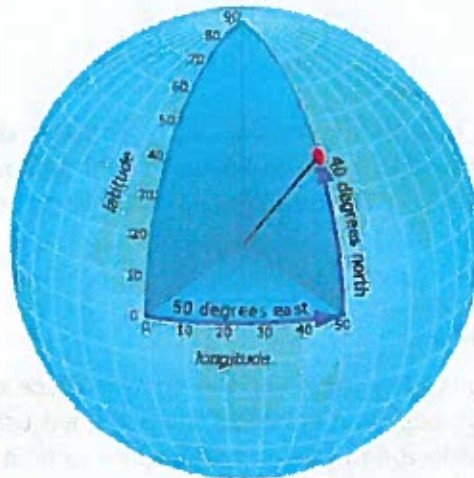

The datum is essentially a reference point that defines from where measurements will originate. Since the Earth is considered to be shaped more like an ellipsoid, the geographic coordinate system as defined by the datum compensates for this. In Canada, the horizontal standard is based on the NAD83 CSRS datum (North American Datum of 1983, Canadian Spatial Reference Systems)ⁱⁱ, which is a modern representation of NAD83 currently used in Newfoundland and Labrador. As for vertical positioning (i.e. elevation), coordinates are typically defined in meters using a vertical datum. In Canada, the vertical standard is based on the CGVD 1928 datum (Canadian Geodetic Vertical Datum of 1928).

To compensate for the spherical nature of the earth, the coordinate system must undergo a geometric transformation to convert a curved space into a flat plane using a map projection. The type of projection depends on the purpose of the map, as all projections contain distortions. A common projection used in NL for local community mapping is Modified Transverse Mercator, Universal Transverse Mercator (UTM) system for regional mappingⁱⁱⁱ.

A Geographic Information System (GIS) is a set of tools that can be used to build mapping layers for a dispatch system when receiving Location Based Data from an emergency call (in an Enhanced or Next Generation 9-1-1 system). A GIS has the ability to create digital interactive maps by overlaying geographic layers, such as road, buildings, parcels, etc. to provide, for the agency dispatching responders, reference information or context to the emergency call location.

Presently, there are well established geographic standards that define locations, datums, and civic addressing methods, such as the ISO 1900 series, the Federal Geographic Data Committee (FGDC) in the US, and the Open Geospatial Consortium (OGC) and the Canadian Geospatial Data Infrastructure (CGDI) in Canada. Additionally, both the National Emergency Number Association (NENA) and the Canadian Radio-television Telecommunications

Commission (CRTC) provide guidance, discussed below, regarding the use of Location-Based Data (LBD) for emergency response purposes.

6.2.1 Location Requirements for E9-1-1 Systems

The location of a caller using a fixed phone line, in an E9-1-1 system is identified using a digital civic address database. An E9-1-1 system generates an Automatic Number Identification (ANI) associated with a phone number and an address. This address is then matched against a geocoded Master Street Address Guide (MSAG) database maintained by the Incumbent Local Exchange Providers (ILEC) (i.e. telephone service provider such as Bell Aliant, Telus, etc.).

Regulations in the US and Canada – again, in an E9-1-1 system – require that the location of a wireless phone be automatically provided to a PSAP along with a call back number. However, the challenge with a mobile phone is that it has no fixed address which means that its location must be determined using a range of technologies to interrogate its location. The process involves using enabling technologies that allow access to the phone's GPS positioning information and/or a range of Cell Network Location Technologies (CNLT). Examples of current CNLT-based methodologies are listed in the endnotes^{iv, v}.

One approach, which combines GPS technology with network information, has been used to achieve a timely and accurate caller location in a range of environments in a cost effective manner. Applying this methodology requires overcoming the complexities associated with standalone GPS technology to acquire satellite signals, the presence of multipath obstructions in urban areas, and/or unfavorable atmospheric conditions, which could all result in significant time delays to determining the caller location in an emergency. To overcome these issues, Assisted GPS (A-GPS or AGPS) has been developed to incorporate reference network information, accelerating the ability of the GPS chip within the mobile device to acquire a satellite code. The reference network can then compute a solution to generate a caller's position. Most implementations of Wireless E9-1-1 in Canada use A-GPS.

The Wireless Service Provider (WSP) is responsible for the operation and maintenance of the reference network, which includes the GPS base station, and the transmission of the GPS location data from the GPS base station receiver to the mobile device (Figure 19).

Figure 19 - An Assisted GPS system^{vi}

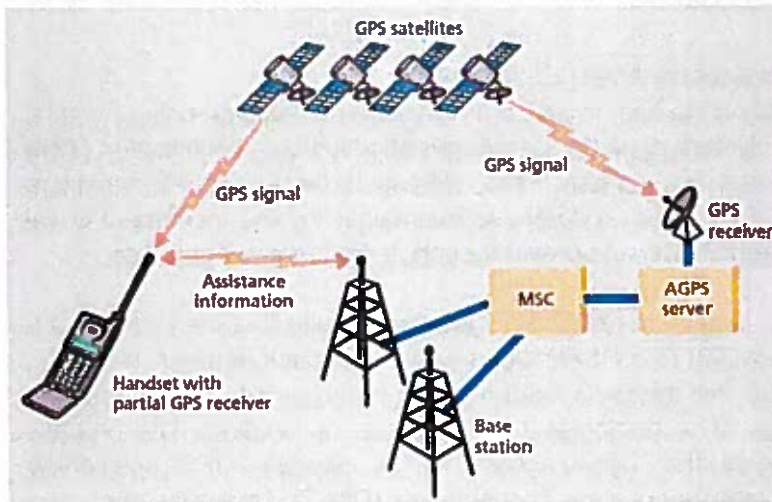

In Q3 of 2011, there were 25,543,862 wireless subscriptions in Canada²¹. To address the growth in cell phone usage related to the access of 9-1-1 services, the CRTC approved consensus report ESRE046²² regarding the Technical and Operational Requirements of Wireless Phase II E911 Implementation – Staged Approach. Whereas Phase I focused on ensuring wireless devices would automatically transmit a callback number and cell site/sector to a local E9-1-1 capable PSAP, the deployment of Phase II was divided into two stages, namely:

- Stage 1: A provision to include X,Y coordinate information and location system parameters that PSAPs use to determine a caller's location.
- Stage 2: A provision to include mid-call location updates and wireless Phase II E911 service for roamers and unsubscribed handsets which will be deployed as technology solutions become available.

As of February 2012 Stage 2 has not been implemented in Canada. However, the implementation of Phase II, Stage 1 has been completed across 131 PSAPs (excluding Yukon, NWT and NL). The CRTC has defined an ALI as a point location defined by a latitude/longitude in the WGS84 datum with a typical accuracy of 10 – 300m. Furthermore, the Telecom Regulatory Policy CRTC 2009-40(13) states that^{vii}:

"13. The Commission considers that making the use of automatic mapping software a prerequisite for the use of X,Y location data would require many PSAPs to make wholesale changes to their systems, potentially posing major funding issues and leading to delays. Moreover, while the Commission encourages PSAPs to use automatic mapping software to the

²¹ http://cwta.ca/wordpress/wp-content/uploads/2011/11/SubscribersStats_en_2011_Q3.pdf

²² A report submitted by the CRTC Interconnection Steering Committee (CISC) Emergency Services Working Group (ESWG)

extent feasible, it is satisfied that any electronic mapping technologies that enable PSAP personnel to quickly input a caller's X,Y coordinates to generate a map location, including Internet provided mapping programs, are sufficient to provide life-saving benefits to the PSAPs and emergency responders."

The decision of the CRTC was to direct the WSPs to enable location services for E9-1-1 wireless calls regardless of whether or not a PSAP had enabled appropriate mapping technology. This phased approach allowed the PSAPs time to purchase and use integrated mapping technology for their E9-1-1 systems as they were able to update. It also allowed for the introduction of web-based mapping services, such as Google Earth and MapQuest, during this transition.

6.3 Relevant Data Sources

6.3.1 Data Requirements

A GIS display is not a requirement for an E9-1-1 system whereas civic addressing is. An Enhanced 9-1-1 system functions at a Basic 9-1-1 system level if civic addressing is not in place. For example, an Enhanced 9-1-1 system would be able to use civic addressing in St. John's – or other municipality with civic addressing – to automatically provide a caller's location. However, if civic addressing is not in place, the automatic location feature of E9-1-1 would not be functional. Nevertheless, the location of a caller using a mobile phone would still be received by an E9-1-1 PSAP even if the call came from an area without civic addressing.

However, GIS is a very useful function of a responding agency's dispatch center (police, fire, or EMS), so that a caller's location can be put into the correct geographic context. Responding emergency services use geographic information to assist in routing crews to an incident location. Many dispatch systems and emergency services use GIS technology from Environmental Systems Research Institute Inc. (ESRI), Intergraph, Bentley, Caris, and/or open source solutions.

Standards and methodology for building GIS data layers for dispatch services and responding agencies are well established. The NL Survey and Mapping Division has GIS data standards, as do other provinces and US states, that clearly delineates the requirements for building databases. Typically, geographic layers in mapping systems include the following:

- Municipal boundaries (Upper and Lower Tier) *
- Census division (In NL, applies only for dissemination of statistics data such as population)#
- Street centerline/Civic Address database *
- Emergency service zones (and station locations) *
- Structure point file (features of importance such as hydrants) *
- Building footprints ^

- Hazardous (natural/anthropogenic) locations ^
- Landmarks *
- Lakes and rivers *
- Orthophotography #
- Cell coverage and tower locations *
- Parcel boundaries ^
- Elevation/contours (topography)#

*critical mapping layers, ^other layers of importance, # useful layers

6.3.2 Available Data as a Basis for Civic Addressing or Responding Agency Geo-locating

6.3.2.1 NL Provincial Data sets

The Government of Newfoundland and Labrador geospatial data sets are managed through relationships between individual lines of business and the Office of the Chief Information Officer (OCIO). Generally, the various departments/divisions build and manage their individual mapping data sets. The Department of Environment and Conservation is one of the lead departments in the NL government for managing mapping data. The Survey and Mapping Division within their department has the mandate for updating and maintaining a range of mapping products, such as community maps, aerial photographs and elevation data. Other Newfoundland and Labrador departments, such as Natural Resources, Transportation and Works, Tourism, Culture and Recreation, and Finance all have GIS databases as well. The provincial government recognizes the importance of mapping data, and had therefore initiated activities within the OCIO to review spatial data holding across the government and implement a systems architecture for the Map Resource Center (spatial data warehouse) in 2009. The geospatial data standards implemented during the creation of this system are based on ESRI GIS software. It may be possible to leverage the infrastructure created by OCIO to support E9-1-1 addressing services.

Examples of relevant data sets are:

- Geoplace Names

The creation and maintenance of the geoplace names geo-database is the responsibility of the Survey and Mapping Division within the Department of Environment and Conservation. Data sets include the names for rivers/lakes, points/features of interest, and place names as shown in Figure 20

Figure 20 - Geoplace names geo-database including river/lake (a), features (b), place names (c)

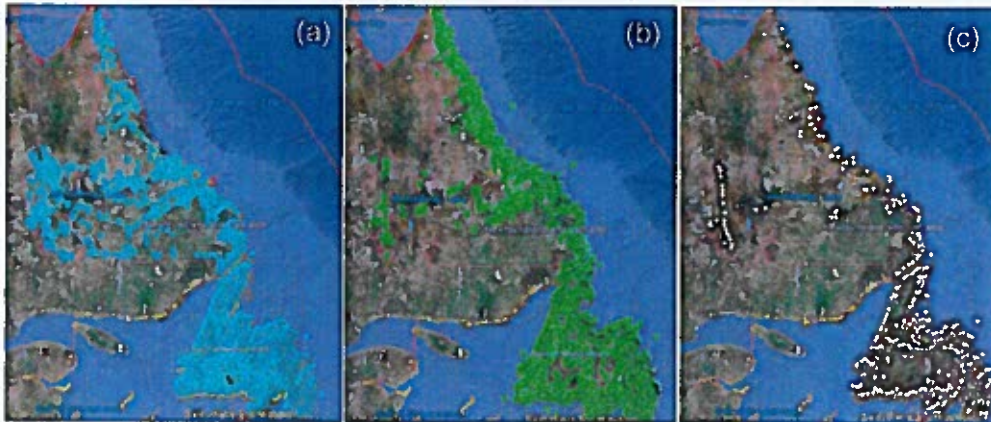

The management of geographical names in Newfoundland and Labrador falls under the mandate of the Newfoundland and Labrador Geographic Names Board (NLGNB), administered by the Survey and Mapping Division. The Board's responsibilities are defined by Section 5 of the *Geographical Names Board Act*. Section 7 of the *Act* also empowers the board to be "the final authority on the spelling and pronunciation of the names of places and geographical features in the province." Section 9 of the *Act* stipulates that "where a provision of this Act is inconsistent or conflicts with a provision, term or condition of the *Labrador Inuit Land Claims Agreement Act*, the provision, term or condition of the *Labrador Inuit Land Claims Agreement Act* shall have precedence over the provision of this Act."

- **Aerial Imagery (film and digital) / Orthoimagery**

The Survey and Mapping Division has been converting Newfoundland and Labrador historical analog film imagery into a scanned digital format. New imagery acquired from 2009 onwards has been obtained as direct digital imagery in partnership with the Forestry Services Branch of the Department of Natural Resources. Imagery acquired before 2009 has been orthorectified within 0.5m whereas subsequent digital imagery has been orthorectified within 0.3m. The extent of geographic coverage of the 2005-2010 aerial imagery, which includes both digitally scanned images and recently collected imagery, is shown in Figure 21.

Figure 21 - Geographic extent of 2005-2010 aerial imagery over NL.

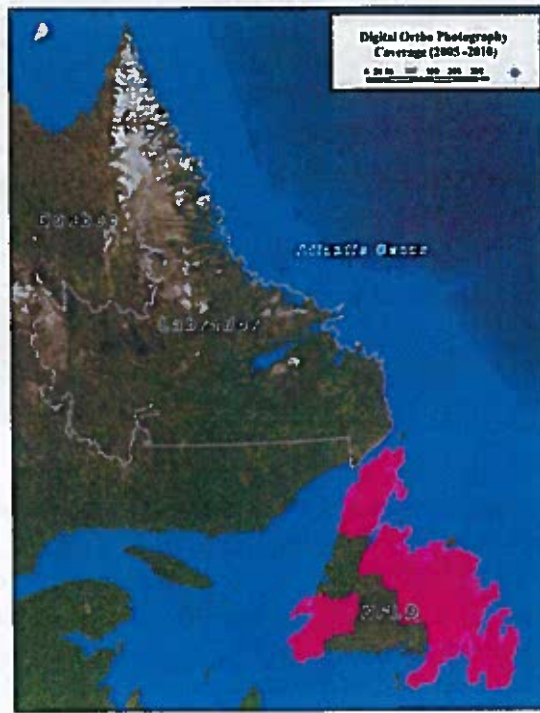

- **Road Centerline Network**

Road centerline data has been created for the province's roads ranging from provincial highways and municipal roads. The data set exists in three forms. First, the Newfoundland and Labrador road centerline network file was provided to Natural Resources Canada to be included into National Road Network file distributed by Geobase. Second, the Survey and Mapping Division has retained a version that includes existing historical civic address information collected in 2004 as a single segmented network in ArcGIS. Third, the NL Department of Transportation and Works uses another version of the road centerline network data within their road management information system which integrates this data with their other road management data sets (e.g bridges and other infrastructure). Their road network file is built using a Linear Referencing System (LRS) for maintaining dynamic segmentation, which allows multiple features on road segments, such as pavement type or speed limits, to be stored in a single file. However, the road centerline data has not been updated in the past two years and it could take approximately three 3 months to complete such an update.

- **Topographic Mapping**

The National Topographic Series Base maps are available, at a scale of 1:250,000 (54 maps) and 1:50,000 (600 maps), for all of Newfoundland and Labrador in a digital mapping

format. The individual maps, which are maintained by the Survey and Mapping Division, include the geoplace names geo-database.

- **Land Registry/Parcel Fabric**

The Ownership Parcels Fabric (OPF) information is available in urban areas, such as Mount Pearl and St John's. Additionally, Crown Land Parcel data for new lands transferred for sales have been created in a digital format and are being managed by the Survey and Mapping Division in a GIS format using ArcGIS by the Survey and Mapping Division.

Unfortunately, a province wide cadastral²³ property fabric does not exist due to the complex, historical nature of land ownership in the province. Since, the registration of conveyances of private land is not required by law in Newfoundland and Labrador, it would be very challenging to create digital mapping layers for legal titles and property boundaries with the title document describing the land.

- **Community Maps**

The Survey and Mapping Division has created Community Maps, the currency of which ranges from ones that have been recently updated to those that have remained unchanged for the past 10 years. The maps were derived from aerial imagery collected for all municipalities and surrounding areas, with the exception of St. John's and Mount Pearl where existing mapping is available. Currently there are 3100 maps at a scale of 1:2500 and 283 maps at a scale of 1:5000.

Since 1991, 1,792 new map sheets have been produced in vector digital format. In addition, 335 of the existing maps were converted from hard copy to vector digital format. All vector data is fully structured for GIS applications. For GIS applications requiring base maps for areas without digitized maps, 1,800 of the older paper maps are available in an unstructured vector digital format or scanned images. These unstructured maps can be used as background images for various GIS applications. The maps are registered to the provincial grid reference system as shown in Figure 22.

²³ A public record, survey, or map of the value, extent, and ownership of land

Figure 22 - Sample of a NL structured community map.

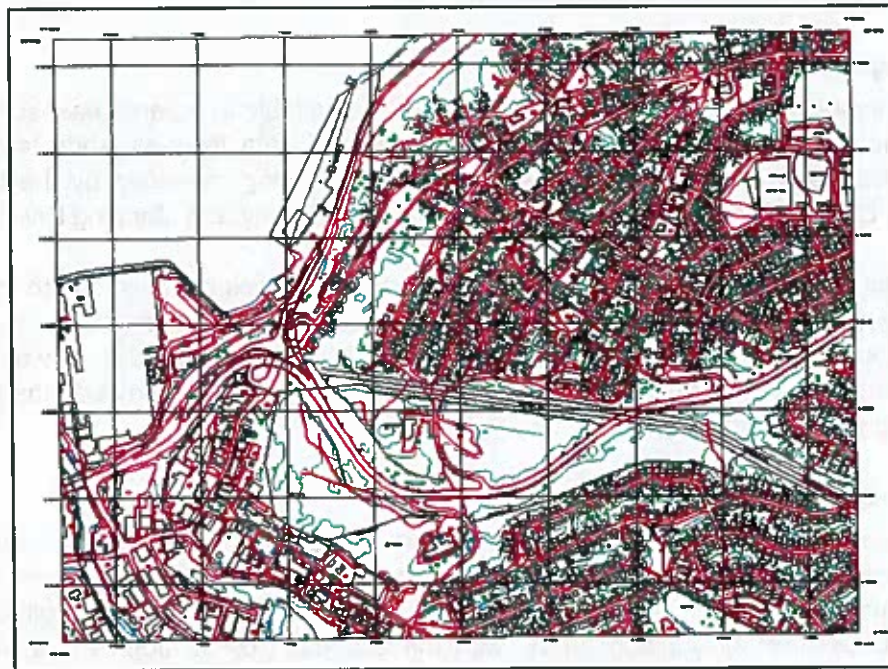

- Municipal Boundaries

The Survey and Mapping Division has mapped the province's municipal boundaries which can be viewed online at MapsNL (www.mapsnl.ca), a web-based tool for displaying NL geographic data (Figure 23).

Figure 23 - MapsNL online interface used for displaying NL mapping data

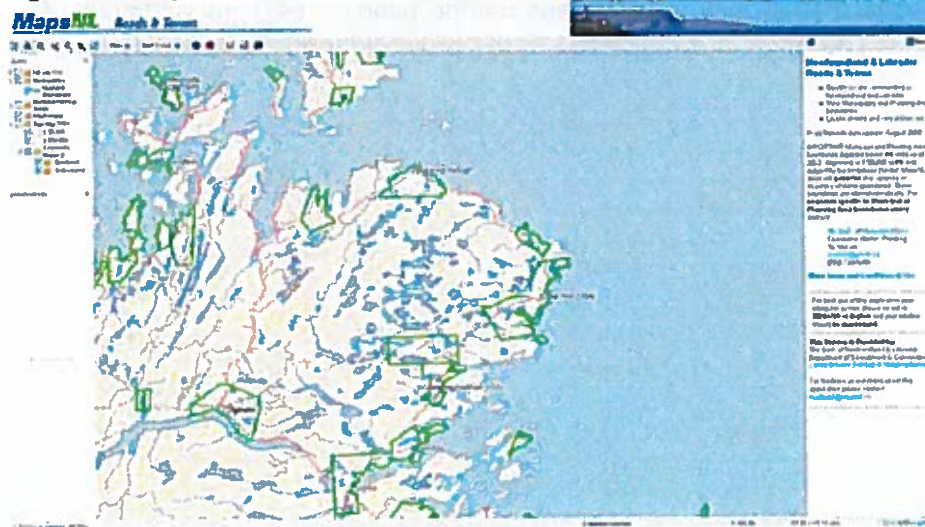

6.3.2.2 Other Data Sources

• **Imagery**

High resolution satellite imagery from Quickbird, Worldview 2, and GeoEye-1 is available over 100% of the province. However, screening for suitable images for digitizing geographic data to support emergency response agency systems (summer images, with less than 5% clouds in the scene and that are considered recent i.e. 2005 and up), leaves approximately 60% - 70% imagery coverage over Newfoundland and Labrador that can be used for this purpose as shown in Figure 24. The imagery geolocating accuracy ranges between 6.5m – 14m with 90% Circular Error Probability (CE90) in the absence of ground control points. However, with available mapping data to be used as Ground Control Points (GCP) imagery can be georeferenced to 1m – 5m. Panchromatic image with these satellite systems have a resolution of 50–70 cm and multispectral images with a resolution of 2–2.5m. The data set can be purchased from a reseller.

Figure 24 - Imagery coverage of summer months with <5% colour cover since 2005 over NL.

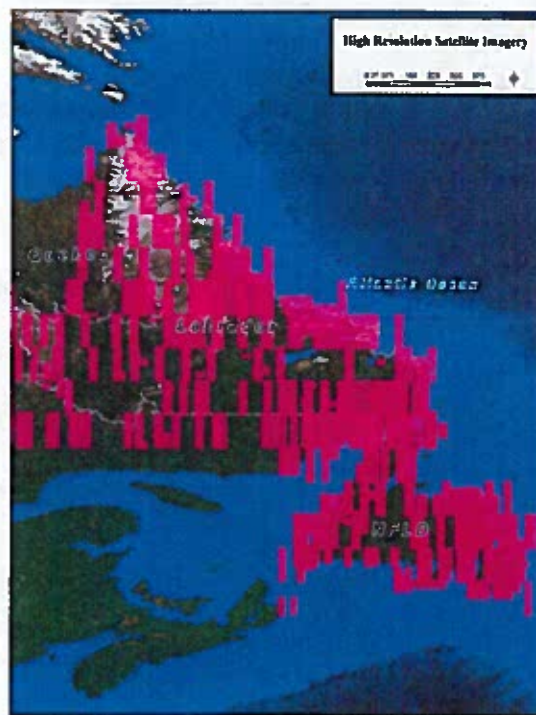

Another satellite system with commercially available imagery is Rapid Eye. Its sensor provides color imagery with 5m resolution. Rapid Eye is currently building a digital archive of imagery for areas across North America, including approximately 70% of Newfoundland and Labrador (Figure 25). A unique feature of the Rapid Eye system is that an image can be

obtained daily over the same area under clear sky conditions. The resulting data can be purchased through a reseller.

Figure 25 - Rapid Eye imagery available for North America.

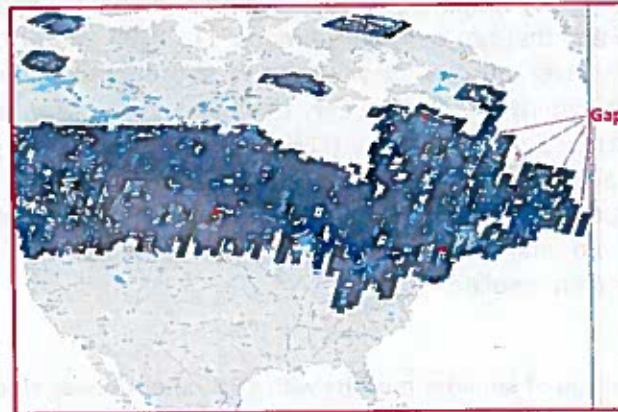

- Cadastral Data

A potential source of cadastral data is the the LandGazette system developed by Information Brokerage Ltd. (IBL) in collaboration with ESRI Canada (Figure 26). LandGazette was developed to create a shared database to which Newfoundland and Labrador land surveyors could submit their survey records for easy access by a wide range of users. LandGazette is the official database of the Association of Newfoundland Land Surveyors.

Figure 26 - LandGazette online interface used for displaying and downloading NL survey data.

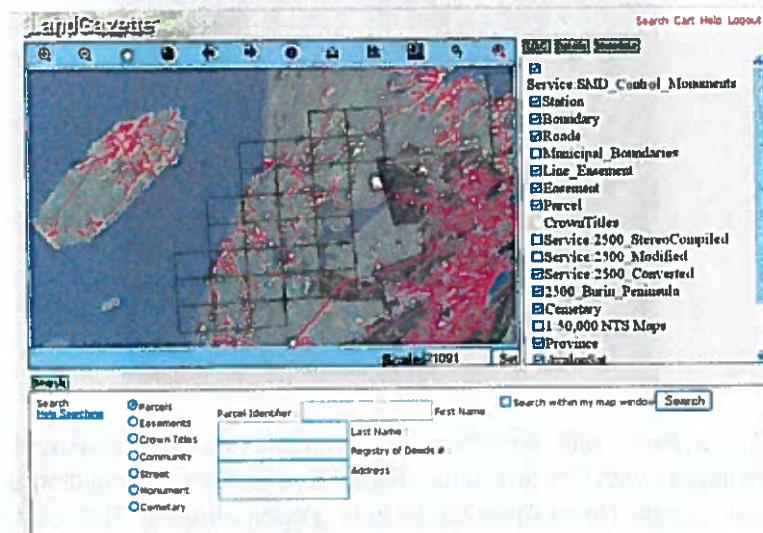

6.4 Data Structure

9-1-1 Location-Based Data (LBD) systems across Canada and the US make use of a data structure that is based on guidelines, standards and policies that come from the CRTC's Emergency Services Working Group (ESWG), relevant CRTC Regulatory Policy rulings, and the National Emergency Number Association's technical guideline documents. Hybrid data structures that are specific to regions and users continue to evolve over time as the types of devices capable of making 9-1-1 calls, such as VoIP technologies, continue to expand. Most recently, the Next Generation 9-1-1 (NG9-1-1) technology has focused on addressing incoming 9-1-1 calls from VoIP, text messaging, or originating from electronic tablets.

There are four location/geographic data elements related to E9-1-1 systems that are considered critical requirements:

1. Identification and transfer of information about a location from a fixed "landline". This information is provided in ASCII text format;
2. For E9-1-1 calls from a mobile device, the Assisted GPS or cell tower triangulation process provide ALI/ANI information in the form of geographic latitude/longitude coordinates in WGS-84 datum in an ASCII text format.
3. A civic address derived from the municipal database is also used to match the ALI/ANI and latitude/longitude location provided to the PSAP by the Incumbent Local Exchange Carrier (ILEC) as a validation check against the other data layers. This process is typically carried out within an enterprise database, such as Oracle, SQL Server, MySQL or PostgreSQL.
4. Base mapping data used by an emergency dispatch agency to provide a geographic context to the target location should include emergency service zones, municipal boundaries, parcels and road centerline with civic addressing. This data is typically handled using GIS application software either in a desktop or a web-based environment. Data should be stored in a geo-database, specifying vendor software file formats or open source Geographic Markup Language (GML) with geometry and attribute information.

NENA also provides guidance on the implementation of interoperability standards for creating and managing location based data structures. NENA has issued a technical guideline document (NENA -02-010 version 9)^{viii} that identifies standard formats for ALI data transactions between the service provider and the database owner/custodian, the GIS data modeling that incorporates Geographic Markup Language, the data dictionary, and the data exchange between the ALI database and the PSAP controller equipment. An objective of this document is to provide recommendations and instructions on how to move towards a more common set of network protocols, such as TCP/IP, for the transfer of data and to promote the use of XML/GML in order to achieve interoperability of Location Based Data between PSAPs.

An important mapping data structure for E9-1-1 systems is a civic addressing database which uses a Master Street Address Guide (MSAG). Civic addressing standards which can be used to

support E9-1-1 systems have already been developed by many provinces in Canada. For instance, PEI has developed guidelines for civic addressing which outline how to deal with the complexities of assigning locations to addresses, dealing with signage, and using a standard road naming convention. Similarly, New Brunswick has established a civic addressing standard and a database (tab delimited text file) of 500,000 call location records (Figure 27)^{ix}.

Figure 27 - Format of the New Brunswick 9-1-1 civic address location database

Name	Type	Size
ID (Unique record identifier)	Number	(12)
PI_PAR_PID (Parcel identifier)	Number	(8)
COUNTY_CD (County code)	Number	(12)
PLN_CD (Place name code)	Number	(3)
ST_TYPE_CD (Street type code)	Number	(2)
STREET_DIR_CD (Street direction code)	Number	(6)
CIVIC_NUM (Civic number)	Text	(6)
CIVIC_NUM_SUFF (Civic number suffix)	Text	(4)
STREET_NAME (Street name)	Text	(30)
COORDINATE_CLASS_CD (Coordinate reference point)	Number	(4)
COORDINATE_METHOD_CD (Method of collection)	Number	(4)
COORDINATE_SOURCE_CD (Source of coordinates)	Number	(4)
X_COORDINATE (Location)	Number	(8)
Y_COORDINATE (Location)	Number	(8)
UNIT_TYPE_CD (Unit type code)	Number	(4)
UNIT_ID (Unit or apartment number)	Text	(255)
FLOOR (Floor the unit is on)	Text	(255)

An illustration of the civic address data structure that has been incorporated into the database using a relational data model, which shows the relationships between different attributes and data elements, is shown in Figure 28.

Figure 28 - Illustration of a relational data model for civic addresses

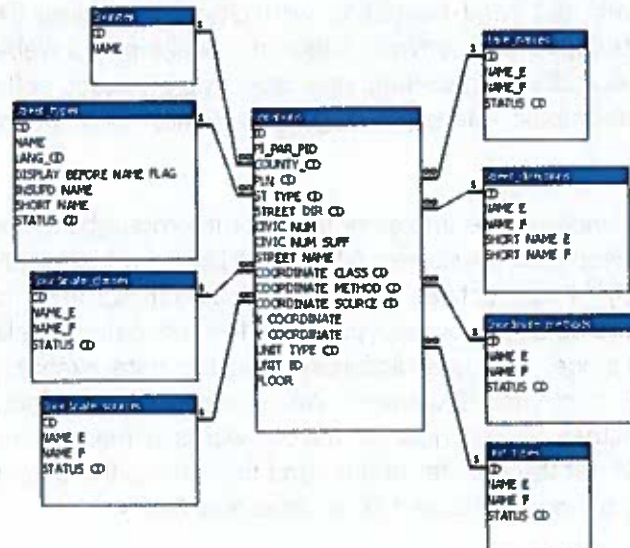

In summary, a data structure for facilitating the exchanging of location data between WSPs, ILEC, and Competitor Local Exchange Carriers (CLEC) to PSAPs is well established, as

demonstrated by the SaskTel network interface report for Saskatchewan. In this particular example, data structures are stored in databases and provided in ASCII data format. Generally, mapping data structures are driven from regulatory and vendor systems utilizing interoperable standards, such as XML/ Geographic Markup Language or Web Mapping Services, where index images of maps are provided for reference.

6.5 Data Gathering and Addressing Used by Other Entities

6.5.1 Newfoundland Power

Newfoundland Power (NP) currently maintains about 70% of the electrical generation and transmission capabilities across Newfoundland, where its customers are located in both rural and urban areas. Defining geographic locations of customers has posed a significant challenge, particularly in rural areas where no civic addressing or parcel fabric is available to uniquely identify a location. To meet their service requirements, NP initiated a pilot project to examine the feasibility of matching the geolocation of each of their customers to their electrical meter's geographical coordinate data. NP is in the process of switching to Automatic Meter Readers (AMR) that can transmit the metered information to a data collection receiver. To properly manage and respond to electrical outages, a business decision was made to geocode the location data of the meters. A pilot project to assess the proposed approach to locate the position of rural customers was carried out in a rural area with a customer base of 30,000. The methodology involved equipping meter readers with Garmin handheld GPS receivers that were set-up in a continuous data collection mode. As the readers acquired the meter data, GPS information was also collected. At the end of the day, post-processing of the GPS data was done to synchronize the meter reading time with GPS time to identify each recorded position. A file containing geographic information was produced which allowed for viewing of the data in Google Earth. This data is being stored in a Microsoft SharePoint Database but will likely be moved into an Oracle or SQL Server database in the future. The project took approximately 2 months to complete.

The data collection involved no strict protocols or stringent quality assurance and was focused on meeting NP business requirements. Locations are likely within 10 – 30m of the meter which is sufficient for their particular business needs. The plan moving forward by NP is to collect data for their remaining customers (~200,000) during the spring of 2012, estimating it will take 3 months to complete. NP is open to collaborating with the province on data and information sharing.

6.5.2 Prince Edward Island (PEI)

In PEI, implementation of an E9-1-1 system required the initiation of a province-wide civic addressing program^x. A procedural standard was developed for civic addressing as well as for the geo-coding of each civic address point. The province developed standards and guidelines for consistent civic addressing for input into their E9-1-1 geo-database. Furthermore, measures were taken to validate existing addresses and to assign addresses in unincorporated areas (i.e.

rural areas). New emergency service zones and community boundaries were developed. In addition, the road centerline network file was expanded to include private roads.

PEI's PSAP is using Caris Locator as their mapping system which also hosts the provincially-managed MSAG database for the E9-1-1 system.

6.5.3 Nova Scotia

The Emergency Management Office (EMO) in Nova Scotia maintains a provincial civic address database, which is cross-referenced with wireless service provider data when a 9-1-1 call is made from a landline^{xi}. The 9-1-1 dispatch software automatically displays the caller's civic address information and then relays it to the appropriate emergency service. Nova Scotia's Civic Address User Guide version 4.1 provides the framework for the database management system used to support location service to E9-1-1 in the province.

In early 2010, E9-1-1 became available across Nova Scotia to locate individuals calling from a mobile device by first approximating the latitude and longitude of the device, then relating these points to data within a geo-database and sending the resulting location information to the appropriate emergency response agency.

6.5.4 Maine

The Office of Information Technology for the State of Maine includes the Maine Office of GIS. This office offers a significant amount of online mapping data for download to GIS systems, including political boundaries, parcels, demographics and imagery. In particular, roads for E9-1-1 application have been created and organized by county and town as a map-book in PDF and GIS shapefile formats (Figure 29). This group's responsibilities include maintaining the 9-1-1 roads database and MSAG^{xii}.

Figure 29 - Web-based interface for downloading E9-1-1 roads data

The screenshot shows a web browser displaying the 'Maine Office of GIS Data Catalog'. The main content area is titled 'Roads (E911) listed by County and Town - shapefiles and PDFs'. Below the title is a table with columns for County, Town, Shapefile, and PDF. The table lists data for various counties including Androscoggin, Kennebec, and Ardennech, with sub-rows for individual towns within each county. Each cell in the table contains icons representing the available data formats (shapefile and PDF).

County	Town	Shapefile	PDF
Androscoggin	Durham	[icon]	[icon]
	Greene	[icon]	[icon]
	Lewiston	[icon]	[icon]
	Litchfield	[icon]	[icon]
	Lyons	[icon]	[icon]
	Lyonsville	[icon]	[icon]
	Lyonsville Falls	[icon]	[icon]
	Lyonsville Falls	[icon]	[icon]
	Lyonsville Falls	[icon]	[icon]
	Lyonsville Falls	[icon]	[icon]
Kennebec	Brookfield	[icon]	[icon]
	Brookfield	[icon]	[icon]
	Brookfield	[icon]	[icon]
	Brookfield	[icon]	[icon]
	Brookfield	[icon]	[icon]
	Brookfield	[icon]	[icon]
	Brookfield	[icon]	[icon]
	Brookfield	[icon]	[icon]
	Brookfield	[icon]	[icon]
	Brookfield	[icon]	[icon]
Ardennech	Ardennech	[icon]	[icon]
	Ardennech	[icon]	[icon]
	Ardennech	[icon]	[icon]
	Ardennech	[icon]	[icon]
	Ardennech	[icon]	[icon]
	Ardennech	[icon]	[icon]
	Ardennech	[icon]	[icon]
	Ardennech	[icon]	[icon]
	Ardennech	[icon]	[icon]
	Ardennech	[icon]	[icon]

6.6 Feasibility Assessment

The following observations can be drawn from this preliminary investigation of Newfoundland and Labrador's requirements with respect to the possibility of Location Based Data, civic addressing, and GIS mapping capabilities:

1. A key spatial data layer required for E9-1-1 services is a road centerline network with civic addresses. The road centerline network for the province exists but requires updating to include existing municipal roads and to identify private roads. Currently, from a mapping perspective, the province does not maintain any changes to municipal roads. Updating would require the allocation of new resources to fund the digital mapping of these newer roads. The effort for this is expected to be on the order of 3-5 months of mapping work. However, only a partial unmaintained civic addressing data set exists with the centerline road file. Civic addressing data would need to be rebuilt to conform to a more comprehensive data model. As well, rural areas would need to be added to the database. Creating civic addresses for all rural areas of Newfoundland and Labrador is an undertaking that would require a significant investment of resources as such an initiative would involve selecting and approving appropriate standards and data models as well as building and validating the data. There are technical and political challenges to consider as well, such as resolving road naming issues across NL communities and rural areas that do not have civic addresses. The implication is that locations of residences would need to be acquired by building a mapping data set through either a GPS-based data collection program and/or extraction of location data from orthoimagery. The province may need to enact legislation to initiate a civic-addressing program. A civic-addressing program would require additional funding in order to be feasible within a reasonable amount of time. Creating an initial civic mapping data set that would make use of existing civic address data, augmented with data collected over unincorporated areas, would likely take 7 to 14 months to build an initial version. However, it would realistically take at least 3 years to improve the accuracy and reliability of the system, and to resolve all data-related civic addressing issues and gaps. Although this process may take several years, it should not be considered a deterrent to establishing a E9-1-1 system across NL but should rather be considered as a building process that will provide wider government benefits from building this data set. The E9-1-1 system could be rolled out using a priority-sequenced process, building the mapping data sets in geographic stages at a community or regional level. The impact of not having an initial province wide civic address database would be minimal as the current system relies on local knowledge held by emergency services in rural areas and could continue to leverage that knowledge during the transitional period as the mapping data would continue to improve over time.
2. The NL government, through the Survey and Mapping Division and Forestry Services Branch of the Department of Natural Resources, is planning to acquire up-to-date aerial orthophotography imagery within the next year for all of Newfoundland. This imagery could be used for future dispatch mapping systems to support geographic data-building through the updating and/or creation of new GIS layers (i.e. roads, buildings, water bodies, etc.). In addition, the imagery would provide an excellent visual reference for

dispatchers and emergency responders to put the emergency call locations into the appropriate geographic context.

3. Existing/historical satellite imagery is available for use in mapping Labrador communities. This imagery could be processed and orthorectified as a data layer to enable digitizing of features of interest and to provide 2D visualization of the communities.
4. Cadastral fabric data is a useful and important piece of information to identify potential locations of emergency calls, however, it is a complimentary layer for mapping displays for emergency incident locating. For instance in rural areas some parcels may have no buildings and may be used for recreational purposes. Information from the Crown Lands parcel database, the urban parcel data sets, and the web-based LandGazette database could be used to create an initial province wide parcel map that could even include some rural areas. The goal would be to create a data-building process that would expand the parcel fabric mapping layer over time. Most urban centers, such as St John's and Corner Brook, have their own parcel mapping data, which could be assembled for this proposed initiative.
5. The OCIO had initiated a corporate GIS and infrastructure program in 2008 - 2009 for geospatial data and creating a central geospatial repository with web mapping services. The infrastructure could be leveraged to support central mapping requirements for an E9-1-1 and emergency dispatch system by providing web-based mapping and MSAG services to PSAPs. Further investigation is required.
6. Newfoundland Power has initiated a project to identify the geographic locations of their customers, particularly in rural areas. The resulting data sets would provide a useful starting point for gathering rural location data to support E9-1-1 locating projects. It may be possible to integrate the collection of these geo-coded locations with the creation of the civic addressing information. Also, imagery and existing road network data could be used to support the building of a civic-address database.
7. Emergency Service Zones (ESZ) would need to be comprehensively mapped for the province of Newfoundland and Labrador. ESZ areas would likely be established by local emergency services in conjunction with the incumbent telephone company, where a mapping process would be implemented to transfer these areas into a formal digital mapping environment.

The foundation mapping data to support civic addressing and E9-1-1 in Newfoundland and Labrador is available and could be assembled rapidly under the political direction of, and with a business mandate from, the government. With the allocation of additional resources to establish a foundation of mapping data, other significant net benefits would be created beyond E9-1-1 applications.

6.7 Recommendations Specific to Mapping and Addressing

There are number of recommendations that, if implemented, would aid in building E9-1-1 mapping data for Newfoundland and Labrador.

1. Create a provincial strategic plan for mapping and addressing, and coordinate efforts to assemble a working group across all lines of business of the NL government, including representatives from other jurisdictions, to establish a provincial geomatics framework with the focus on E9-1-1 and emergency service dispatch systems, and geospatial data needs. This working group would be mandated to determine objectives and priorities, to formulate a plan for moving forward, to identify possible delivery mechanisms and assign responsibilities. Where appropriate, the review and realignment of existing mandates and resources would be undertaken to better support E9-1-1 mapping activities. This should be driven by the data users, such as Fire and Emergency Services, and data providers, such as the Survey and Mapping Division. The OCIO, acting as the corporate IT manager and governance officer, would support the maintenance and distribution of the data. The OCIO had established a Geographic Technical Committee which could evolve to support the mapping requirements as well.
2. Create legislative regulatory responsibility, such as an "*E9-1-1 Implementation Act*", that would have a similar type of mandate as the "*Geographical Names Act*", and would help oversee, manage, and govern implementation of E9-1-1 mapping data requirements. The selected responsible body would have the decision-making authority to establish an E9-1-1 technical mapping group. The mandate and direction would be directed by the *Act* and by the provincial strategic plan. The technical group should be comprised of representatives from various Newfoundland and Labrador departments and should also include additional stakeholders, such as municipal partners (i.e. utilities) and enforcement authorities (i.e. RCMP/RNC/FESNL).
3. Establish a 9-1-1 geospatial architecture, and standards to support E9-1-1 data-building, which would build on existing work done by the OCIO and other Newfoundland and Labrador departments to ensure interoperability and continuity. This would include leveraging existing civic addressing standards and creating a data model appropriate for Newfoundland and Labrador. This may also include creating web mapping services to support PSAP pending the outcome of strategic direction.
4. Conduct a more thorough investigation of available mapping data used by the Newfoundland and Labrador government, universities, the federal government (Canada Post/Statistics Canada), and third parties including Bell Alliant, Nalcor Energy, and Newfoundland Power to support data-building. This investigation should include consideration of data quality, data costs, and access and sharing agreements.
5. Implement an incremental building approach to create mapping data by conducting an iterative data-building process starting with a set of pilot studies to better understand the complexities and issues of civic addressing. This process should go forward independently from the decision process to enable E9-1-1 service expansion across Newfoundland. The reason is that building E9-1-1 data sets would have long-term benefits to other government applications, such as disaster response, land use planning,

infrastructure requirements, financial analysis, and safety planning, making the initial resource investment worthwhile.

6. Utilize a multi-criteria spatial modeling approach to prioritizing when and where E9-1-1 data mapping would be undertaken. This prioritization exercise would be based on ranking and weighing demographic data, availability of mapping data, potential usage, cost, and infrastructure requirements.

Previous attempts in the mid-1990s to implement a 9-1-1 system were impeded by the lack of infrastructure, geospatial data availability (i.e. civic addressing) and costsⁱⁱⁱ. Today, lack of mapping data is not as much of a limitation as it was during the 1990s since more data is now available that can be repurposed for emergency 9-1-1 applications. Furthermore, technological advancements have made supporting E9-1-1 through web mapping services more cost effective and efficient as well.

The establishment of civic addressing to support E9-1-1 systems across Newfoundland and Labrador using Location Based Data is very much feasible but will require financial investment and a governing body with a clear mandate and decision-making authority to achieve this goal.

7 Conclusion and Recommendation

Readers might surmise, based on the content of this report, that the province could quickly expand the existing 9-1-1 system and then proceed with the implementation of Enhanced 9-1-1. From a purely technical perspective that is possible; but from the perspective of best practice, project management, and optimal delivery of 9-1-1 to the public, that would be an erroneous method of proceeding.

Instead, the province's next step – if it proceeds with expanded 9-1-1 – is to strike a senior level working group to further define a plan for 9-1-1 implementation. Other steps should include the following:

- Schedule a facilitated session of the working group to explore the steps and duration required to expand 9-1-1 in the province. Topics of discussion should include legislation, governance, regulations, organization, administration, operations, and an implementation process.
- Determine the lead or primary Department for provincial 9-1-1 activities and authority.
- Determine a governance structure.
- Draft and enact legislation authorizing governance and the activities of a provincial 9-1-1 Bureau.
- Create and staff a 9-1-1 Bureau under the auspices of the responsible Department.
- Initiate a province-wide 9-1-1 education program so that residents understand the purpose, capabilities and limitations of a 9-1-1 system.

We recommend that the province's next step is not to expand the existing 9-1-1 system, but to initiate a planning group to put in place the steps described immediately above.

In conclusion, we find that a cautious, progressive, and planned implementation of Basic 9-1-1 and, eventually, a multi-year plan resulting in the implementation of Next Generation 9-1-1 throughout Newfoundland and Labrador is quite feasible at an estimated (based on what we know at this time), equivalent of less than \$0.75 per month per telephone line or wireless subscription.

8 Appendix A - References

http://nena.site-ym.com/resource/collection/ABEAA8F5-82F4-4531-AE4A-0AC5B2774E72/NENA_56-005_9-1-1_Call_Answering_Standard.pdf (Accessed Nov 30, 2011)

http://www.nena.org/resource/collection/6366E817-C855-4776-AF3A-F9F715D1AF12/NENA_02-011-v6_9-1-1_Data_Management.pdf (Accessed Dec 2, 2011)

9 Glossary

Association of Public Safety Communication Officials (APCO) - APCO International is reported to be the world's largest organization of public safety communications professionals. It serves the needs of public safety communications practitioners by providing expertise, professional development, technical assistance, advocacy and outreach.

Automatic Number Identification (ANI) – is a feature of intelligent telephone network services that permits subscribers to display or capture the billing telephone number of a calling party.

Automatic Location Identification (ALI) – is an enhanced electronic location system that automatically relays a caller's address when they call an emergency responder service such as 9-1-1.

Basic 9-1-1 – An emergency contact system via telephone that recognizes when someone dials that number and routes the call to the nearest answering point based on the call originator's location.

Bureau Hold – allows a PSAP operator to hold onto a 9-1-1 callers line in case the caller is not able to talk or suddenly disconnects the call.

Canadian Radio-television Telecommunications Commission (CRTC) – regulates prices and some activities of communications companies in Canada

Circuit switched 9-1-1 network - is a data transmission service requiring the establishment of a circuit-switched (somewhat mechanical) connection before data can be transferred.

Competitive Local Exchange Carrier (CLEC) – a telecommunications company competing with other, already established carriers (generally the incumbent local exchange carrier (ILEC)). Sometimes the CLEC uses the ILEC's network infrastructure.

Computer Aided Dispatch (CAD) – is a method of dispatching emergency services assisted by computer. The computer interacts with other electronic systems such as GIS, automatic vehicle location, other mapping, etc.

Cost Recovery Fee – is collected by phone companies on a set rate per wireline, and sometimes wireless, phone on behalf of the governing jurisdiction for 9-1-1. The fee is used to recover the province's costs in connection with the provision of 9-1-1 Services. It is also traditionally used to cover all costs and expenses incurred by the province to provide 9-1-1 capability and functionality including, but not limited to: software acquisition and maintenance, equipment purchases and maintenance, labor to install and maintain the equipment and software, 9-1-1 call answer center staffing, and costs of public awareness campaigns.

Computer Telephony Integration (CTI) or Computer Telephony Interface - is a common name for any technology that allows interactions on a telephone and a computer to be integrated or coordinated. The

term is predominantly used to describe desktop-based interaction for helping users be more efficient, though it can also refer to server-based functionality such as automatic call routing.

Demarcation Point – In telephony, the demarcation point is the point at which the public switched telephone network ends and connects with the customer's on-premises wiring. It is the dividing line which determines who is responsible for installation and maintenance of wiring and equipment – customer/subscriber, or telephone company/provider. (Wikipedia)

Emergency Call Routing Function (ECRF) – ECRF provides 9-1-1 call routing control. It is a functional element in an ESInet (network component of NG9-1-1 system) where location information (either traditional civic address or geo-coordinates) is used to route an emergency call to the appropriate PSAP or secondary answer center for the caller's location

Emergency Services Internet Protocol network (ESInet) - ESInet is a managed data network that provides the transport backbone for NG9-1-1 services. The network can be shared by multiple public safety agencies or PSAPs and can be used to support other applications and data sharing.

Emergency Services Working Group (ESWG) - The CRTC ESWG is composed of Telecommunication Service Providers, Public Safety Answering Points (PSAPs), and 9-1-1 Industry specialists. The Working Group addresses issues that relate to the provisioning of 9-1-1 services. This includes the technical and operational implementation of 9-1-1 services as assigned by the CRTC or as requested by stakeholders.

Enhanced 9-1-1 – An emergency number that, in addition to Basic 9-1-1, displays the telephone number, name, and associated address of the telephone service. Within this report, Enhanced 9-1-1 is also sometimes referred to as 'traditional Enhanced', or 'legacy Enhanced' to differentiate that technology from Next Generation 9-1-1 which could be considered a more robust type of Enhanced 9-1-1.

Federal Communications Commission (FCC) - an independent government agency that regulates interstate and international communications by radio and television and wire and cable and satellite

Geographic Information System (GIS) – a system designed to capture, store, manipulate, analyze, manage, and present all types of geographically referenced data

Incumbent Local Exchange Carrier (ILEC) – in Canada is a local telephone company that was in existence at the time that the telephone company was deregulated and no longer supported by taxation funding.

Instant Messaging (IM) - a form of real-time direct text-based chatting communication in push mode between two or more people using personal computers or other devices.

Intrado – A publicly traded company that provides 9-1-1 operations support systems services to incumbent local exchange carriers, competitive local exchange carriers and wireless carriers.

IP Relay – Web based text relay service is an operator service that allows people who are hearing impaired or speech disabled to place calls to standard telephone users via a keyboard or assistive device.

Location Information Server (LIS) – A Location Information Server in a NG9-1-1 system provides locations in geo-coordinates or civic addressing format and is a transitional service equivalent to a traditional ALI database containing the Master Street Address Guide.

Master Street Address Guide (MSAG) – is a companion database to the ALI database that describes the exact spelling of streets, street number ranges, and other address elements. When a call is received at a PSAP with Enhanced 9-1-1 capabilities the address is looked up in the Master Street Address Guide to find the appropriate Emergency Service Number (usually the responding agency's dispatch center) to which 9-1-1 calls from the calling phone number should be routed.

The National Emergency Number Association NENA - is a professional organization solely focused on 9-1-1 policy, technology, operations, and education issues. It has over 7,000 members across the United States and around the globe. NENA promotes the implementation and awareness of 9-1-1, as well as international three-digit emergency communications systems.

The National Fire Protection Association NFPA - is a nonprofit organization that advocates for fire prevention and public safety. It develops, publishes, and disseminates more than 300 consensus codes and standards intended to minimize the possibility and effects of fire and other risks. The NFPA has more than 70,000 members worldwide.

Narrowband - Generally, narrowband describes telecommunication that carries voice information in a narrow band of frequencies. More specifically, the term has been used to describe a specific frequency range set aside by the FCC for mobile or radio services, including paging systems, from 50 cps to 64 Kbps.

Next Generation 9-1-1 (NG9-1-1) - refers to an initiative aimed at updating the 9-1-1 service infrastructure in the United States and Canada to improve public emergency communications services in a wireless mobile society. In addition to calling 9-1-1 from a phone, it intends to enable the public to transmit text, images, video and data to the 9-1-1 center. The initiative also envisions additional types of emergency communications and data transfer. The NG9-1-1 infrastructure is intended to replace the current services over time. The National Emergency Number Association (NENA) first identified the need for NG9-1-1 in 2000, and started development actions in 2003, and is nearing full definition and standards for NG9-1-1.

North American Numbering Plan (NANP) - is an integrated telephone numbering plan administered by Neustar (formerly Lockheed Martin IMS) which encompasses 24 countries and territories, including the United States and its territories, Canada, Bermuda, and 16 nations of the Caribbean.

Operational Communications Center (OCC) – usually a police or other emergency service communications center; for example: RCMP OCC; RNC OCC.

Primary Rate Interface (PRI) – is a standardized telecommunications service level within the Integrated Services Digital Network (ISDN) specification for carrying multiple voice and data transmissions between a network and a user.

Public Safety Answering Point (PSAP): A public safety answering point is a call center responsible for answering calls to an emergency telephone number for police, firefighting and emergency medical services. A PSAP could be a neutral answering point which means that its sole role is to receive an initial emergency call and route the caller to an appropriate public safety agency, which would then gather more detailed information from the caller and dispatch emergency responders. A PSAP may also be part of an emergency services response agency, such as the Royal Newfoundland Constabulary or the St. John's Regional Fire Department, which would dispatch 9-1-1 calls for its own department and transfer other calls to the appropriate agency to be dispatched.

Public Switched Telephone Network (PSTN) – is the network of the world's public circuit-switched telephone networks. It consists of telephone lines, fiber optic cables, microwave transmission links, cellular networks, communications satellites, and undersea telephone cables, all inter-connected by switching centers, allowing any telephone in the world to communicate with any other.

Real-Time Text (RTT) - is streaming text that is continuously transmitted as it is typed or otherwise composed. It allows conversational use of text, where people interactively converse with each other.

Ringback – in a 9-1-1 system allows the call-taker to contact the caller if he/she accidentally hangs up or collapses during the call before all the necessary information is obtained.

Secondary Call Answer Centers – are the emergency dispatch centers to which an emergency call for assistance is passed by the primary Public Safety Answering Point (PSAP). The PSAP determines whether a caller requires police, ambulance, or fire services and quickly transfers the caller to the designated secondary location which can dispatch assistance.

Selective Routers (SR) – a small phone switch which contains a database of automatic number identification or information (ANI) records — i.e., phone numbers — for local subscribers.

Service Fee – is a tariff, approved by the CRTC, that is collected by telephone companies for each wireline and wireless phone to cover the costs of developing and maintaining a 9-1-1 network including trunk lines, selective routing software and hardware, ANI/ALI database development and maintenance, and the termination of 9-1-1 calls at the demarcation point of a PSAP and secondary call answer centers.

Short Message Service (SMS) – is a text messaging service component of phone, web, or mobile communication systems, using standardized communications protocols that allow the exchange of short text messages between fixed line or mobile phone devices.

Tandem – In telephone hierarchy a Tandem is a term for a central office (called class 4) that links other central offices (called class 5) with trunks. It can be thought of as a switching center that connects switches to other switches.

Tariff - a list or schedule of prices. In the case of 9-1-1, telephone companies apply to the CRTC to recapture costs associated with the provision of 9-1-1 infrastructure and service.

Voice Over Internet Protocol (VoIP) – is a family of technologies, methodologies, communication protocols, and transmission techniques for the delivery of voice communications and multimedia sessions over Internet Protocol (IP) networks, such as the internet. Other terms frequently encountered and often used synonymously with VoIP are IP telephony, Internet telephony, voice over broadband (VoBB), broadband telephony, and broadband phone.

Wireless Service Providers (WSP) – companies that provide wireless, or cellular, communication to customers. In Newfoundland and Labrador wireless service is provided by Bell Mobility, Rogers Communications, Telus, and Wind Mobile.

Wireline – a traditional telephone communications method where a telephone is physically connected to the telephone network by a cable or wires.

ⁱ <http://www.ag.gov.nl.ca/ag/annualReports/2005AnnualReport/CH2.19.pdf>

ⁱⁱ ftp://ftp.geod.nrcan.gc.ca/pub/GSD/craymer/pubs/nad83_geomatica2006.pdf

ⁱⁱⁱ <http://www.env.gov.nl.ca/env/maps/standards.html>

^{iv} http://www.ipcgps.com/uploads/docs/Intro_to_Location_Technologies-1.pdf

^v <http://www.gps-practice-and-fun.com/a-gps.html>

^{vi} <http://cens.ucla.edu/~mhr/cs219/location/djunkic01.pdf>

^{vii} <http://www.crtc.gc.ca/eng/archive/2009/2009-40.htm>

^{viii} http://nena.site-ym.com/resource/collection/C74A8084-E3BD-405D-93C2-48AFCFA5B490/NENA_02-010-v9_Data_Formats_for_ALI_MSAG_GIS.pdf

^{ix} http://www.snb.ca/gdam-lqec/e/2900e_1f_i.asp

^x Department of Environment, Labour and Justice, Prince Edward Island. 2011. E911 Answer/Transfer System. <<http://www.gov.pe.ca/jps/index.php3?number=1004190&lang=E>> Accessed January 11, 2012.

^{xi} Emergency Management Office, Nova Scotia. 2011. 9-1-1. <<http://emo.gov.ns.ca/content/9-1-1>> Accessed January 11, 2012.

^{xii} <http://www.maine.gov/megis/e911/index.shtml>

^{xiii} <http://www.ag.gov.nl.ca/ag/annualReports/2005AnnualReport/CH2.19.pdf>

